

Marina Office Building

Office Building Concept Design
 Location: Marina District, Doha, Qatar,
 Plot: Marina Com 017
 Date: Nov. 2013

Author:
 Arch. Marius-Traian Danciu
 Ecopolis Architecture Group-Bucharest

mariusdanciu.ecopolis@yahoo.com
 marius.danciu@ecopolis.ro
 tel: +40726 260424
 www.ecopolis.ro
 www.contactstudio.ro
 www.proatrium.ro



Office Building - Marina District, Doha, Qatar, Marina com 017

date: nov. 2013

This project is the property of the Author and may not be used without his permission.

www.ecopolis.ro
 www.contactstudio.ro

Facades Concept

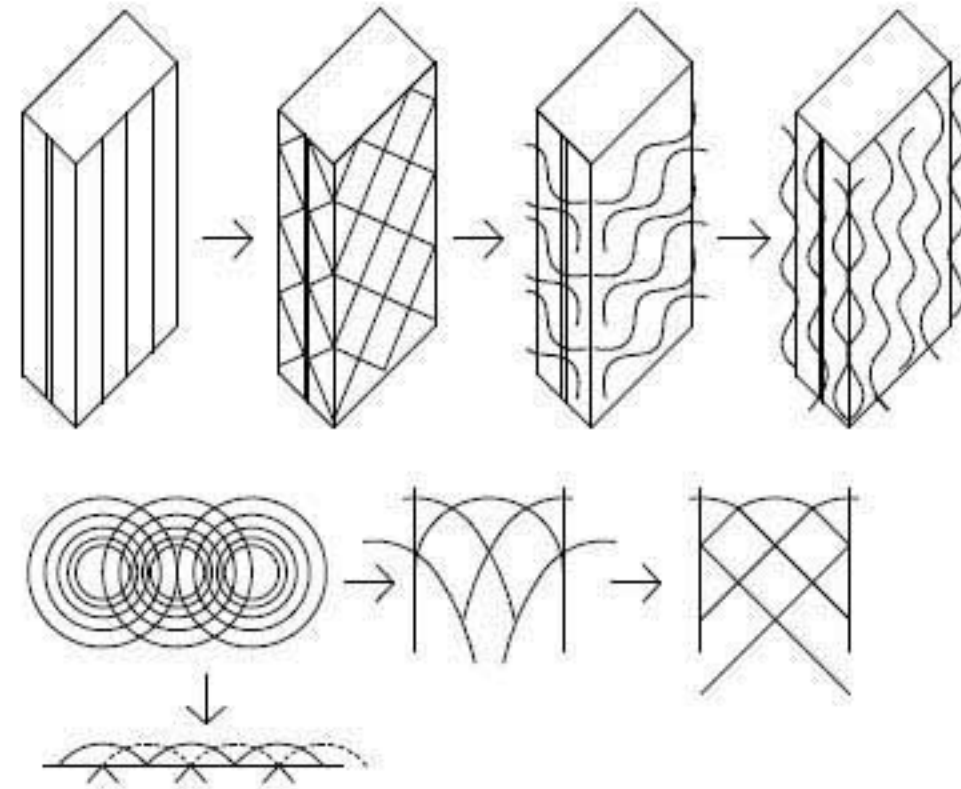

Functional Concept

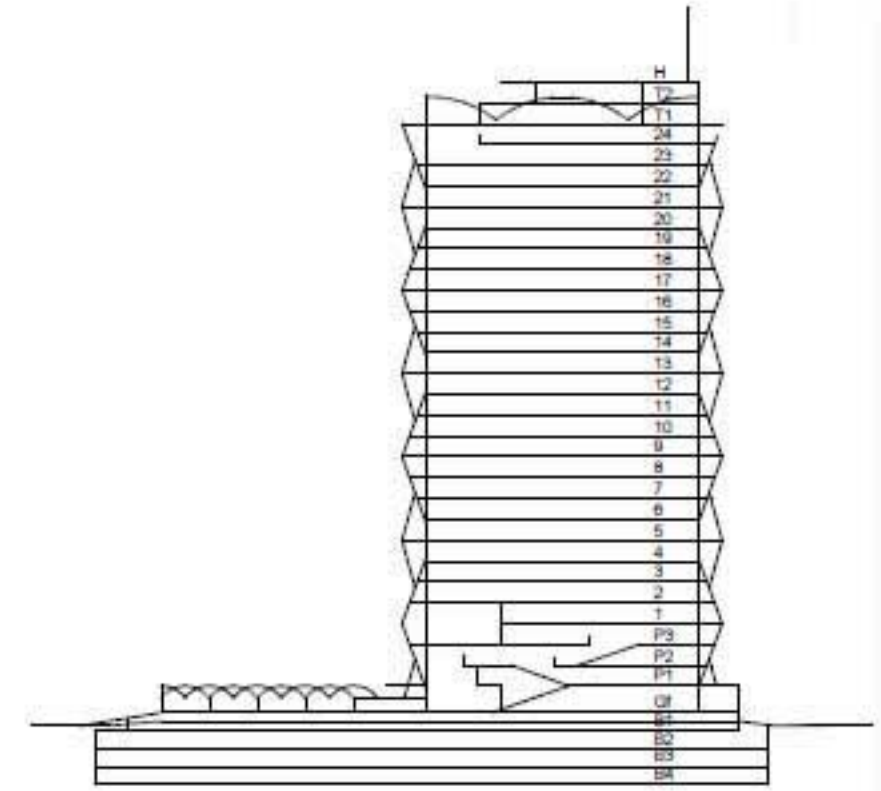
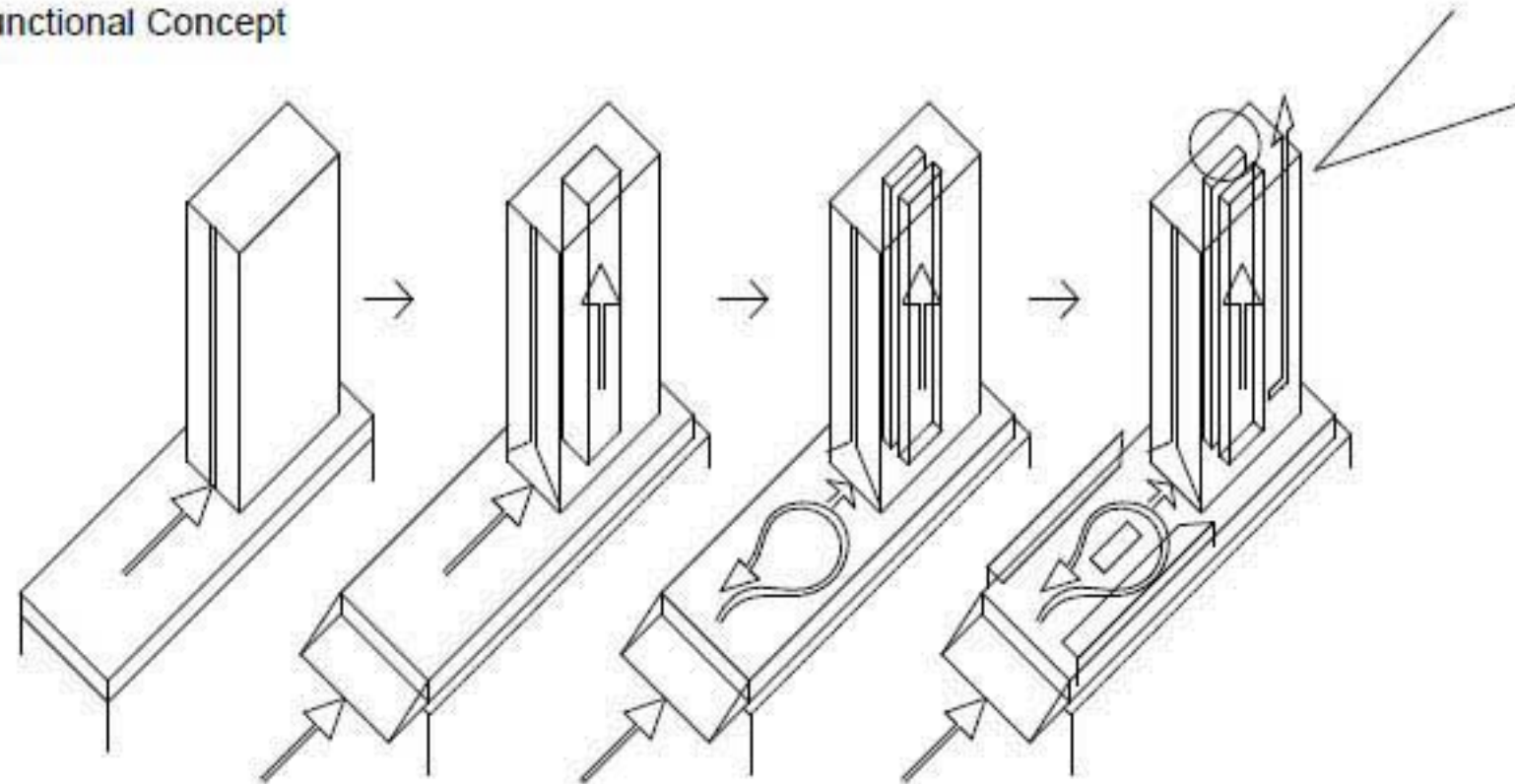

Ecopolis
Architecture
Group

This project is the property of the Author and may not be used without his permission.

Marina Office Building

Office Building Concept Design
Location: Marina District, Doha, Qatar,
Plot: Marina Com 017
Date: Nov. 2013

Author:
Arch. Marius-Traian Danciu
Ecopolis Architecture Group-Bucharest

mariusdanciu.ecopolis@yahoo.com
marius.danciu@ecopolis.ro
tel: +40726 260424
www.ecopolis.ro
www.contactstudio.ro
www.proatrium.ro

www.ecopolis.ro
www.contactstudio.ro

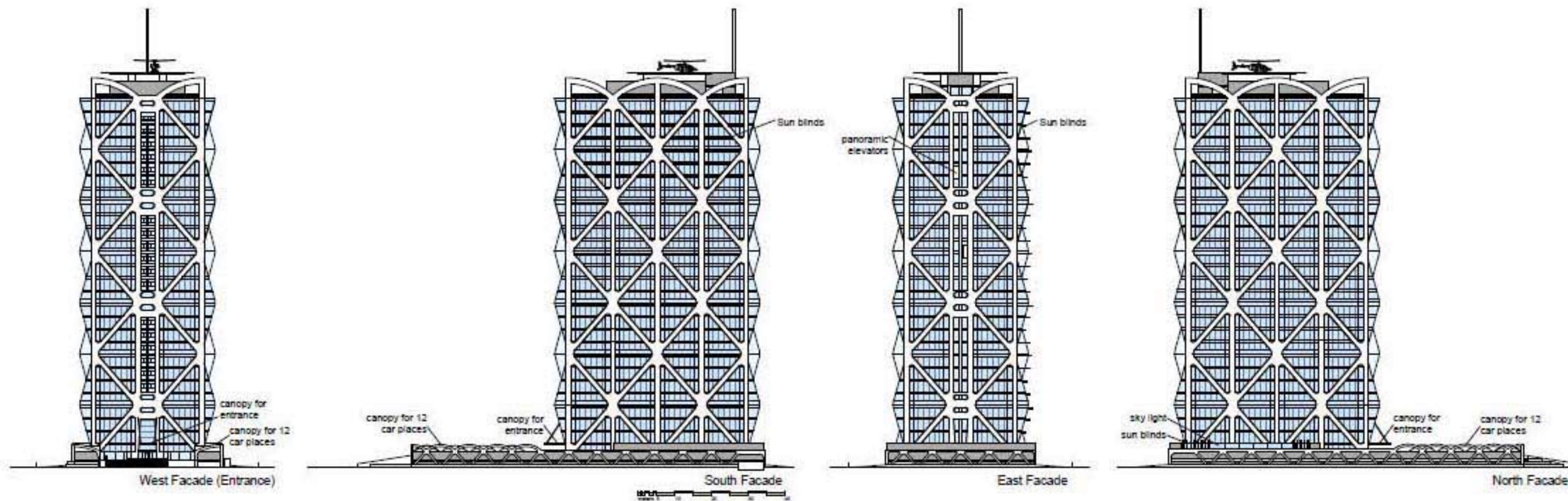

Marina Office Building

Office Building Concept Design
 Location: Marina District, Doha, Qatar,
 Plot: Marina Com 017
 Date: Nov. 2013

Author:
 Arch. Marius-Traian Danciu
 Ecopolis Architecture Group-Bucharest

mariusdanciu.ecopolis@yahoo.com
 marius.danciu@ecopolis.ro
 tel: +40726 260424
 www.ecopolis.ro
 www.contactstudio.ro
 www.proatrium.ro

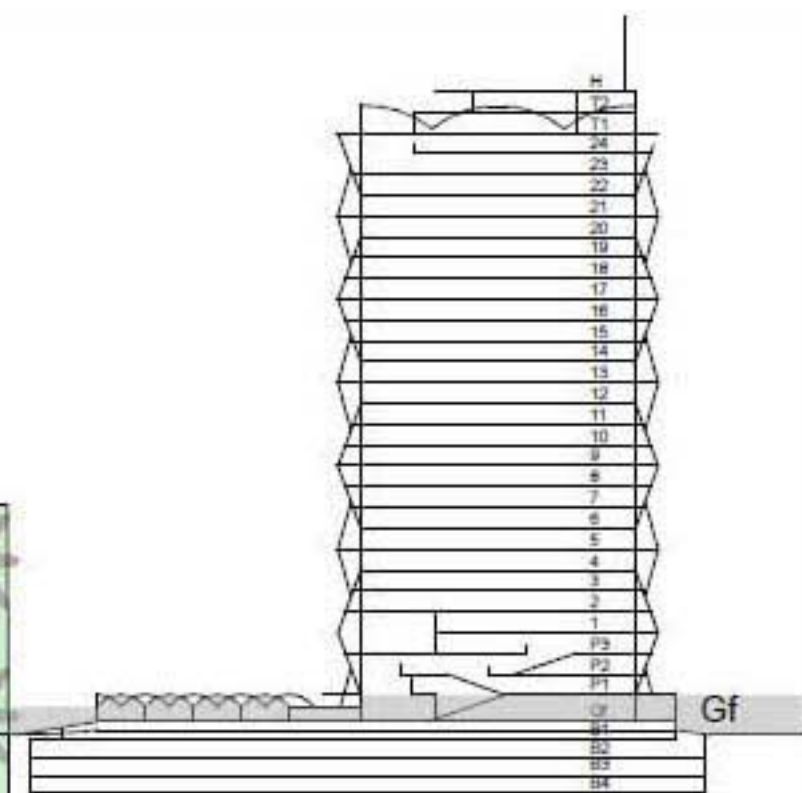
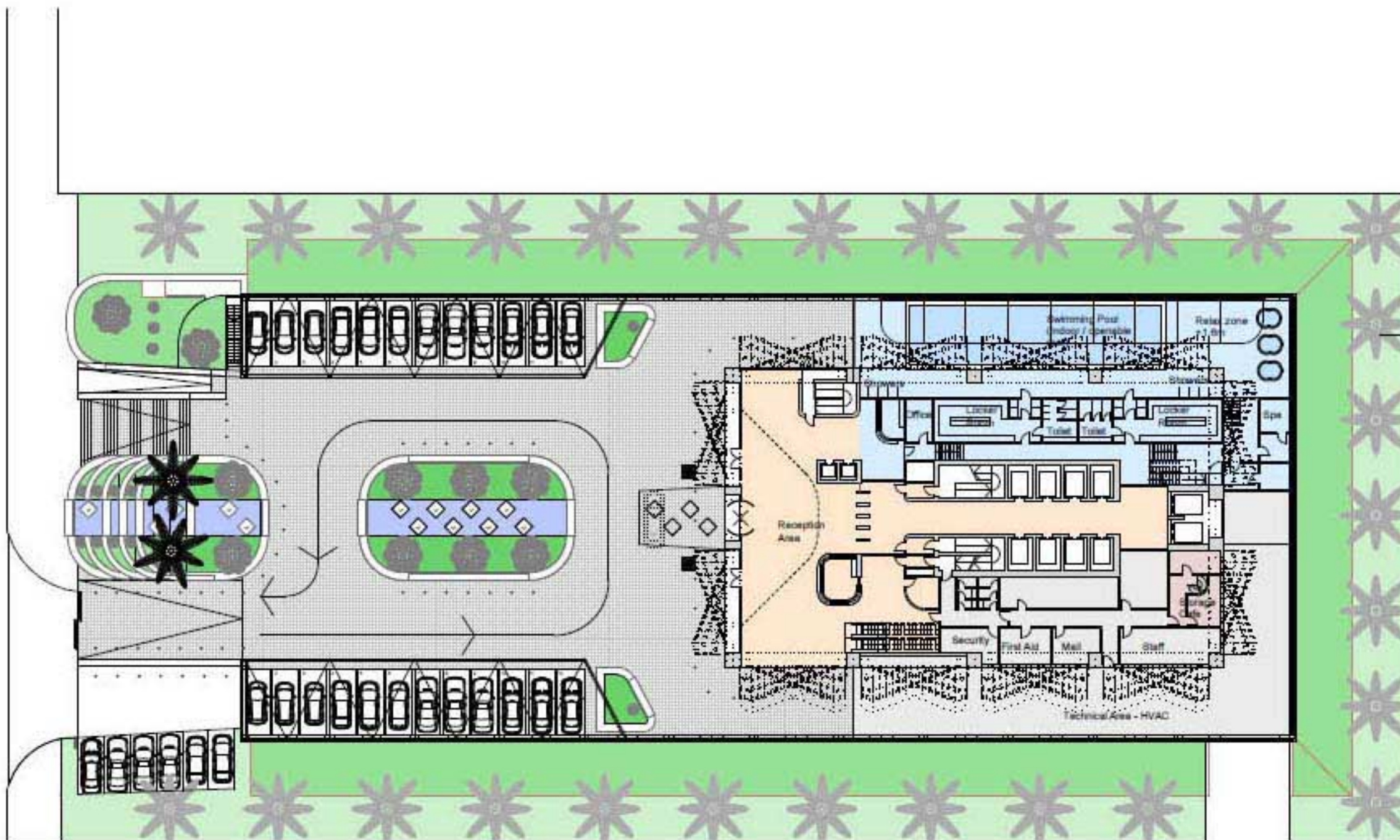

- Ground Level +1.5m**
- Floor Common Area - 450 sqm
 - Commercial Area * (Fitness & Spa) - 550sqm
 - Technical area and shafts - 580 sqm
 - Building structure
 - Car Parking places - 34covered / 6 uncovered
 - Vertical Circulation (Stairs/Elevators)
 - Escalators
 - Toilets
 - Cafe Bar 35 sqm
 - Plaza
 - Green Area with/without Basement
 - Fountain

* Commercial Area could also be a restaurant or a firm - 2 floors

Gross Area: 2000 sqm
 Parking Canopy Area: 510sqm
 Total Area: 2510 sqm

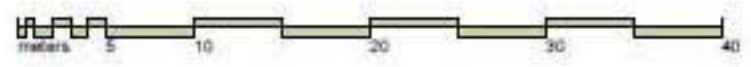

This project is the property of the Author and may not be used without his permission.

Marina Office Building
 Office Building Concept Design
 Location: Marina District, Doha, Qatar,
 Plot: Marina Com 017
 Date: Nov. 2013

Author:
 Arch. Marius-Traian Danciu
 Ecopolis Architecture Group-Bucharest

mariusdanciu.ecopolis@yahoo.com
 marius.danciu@ecopolis.ro
 tel: +40726 260424
 www.ecopolis.ro
 www.contactstudio.ro
 www.proatrium.ro

www.ecopolis.ro
 www.contactstudio.ro

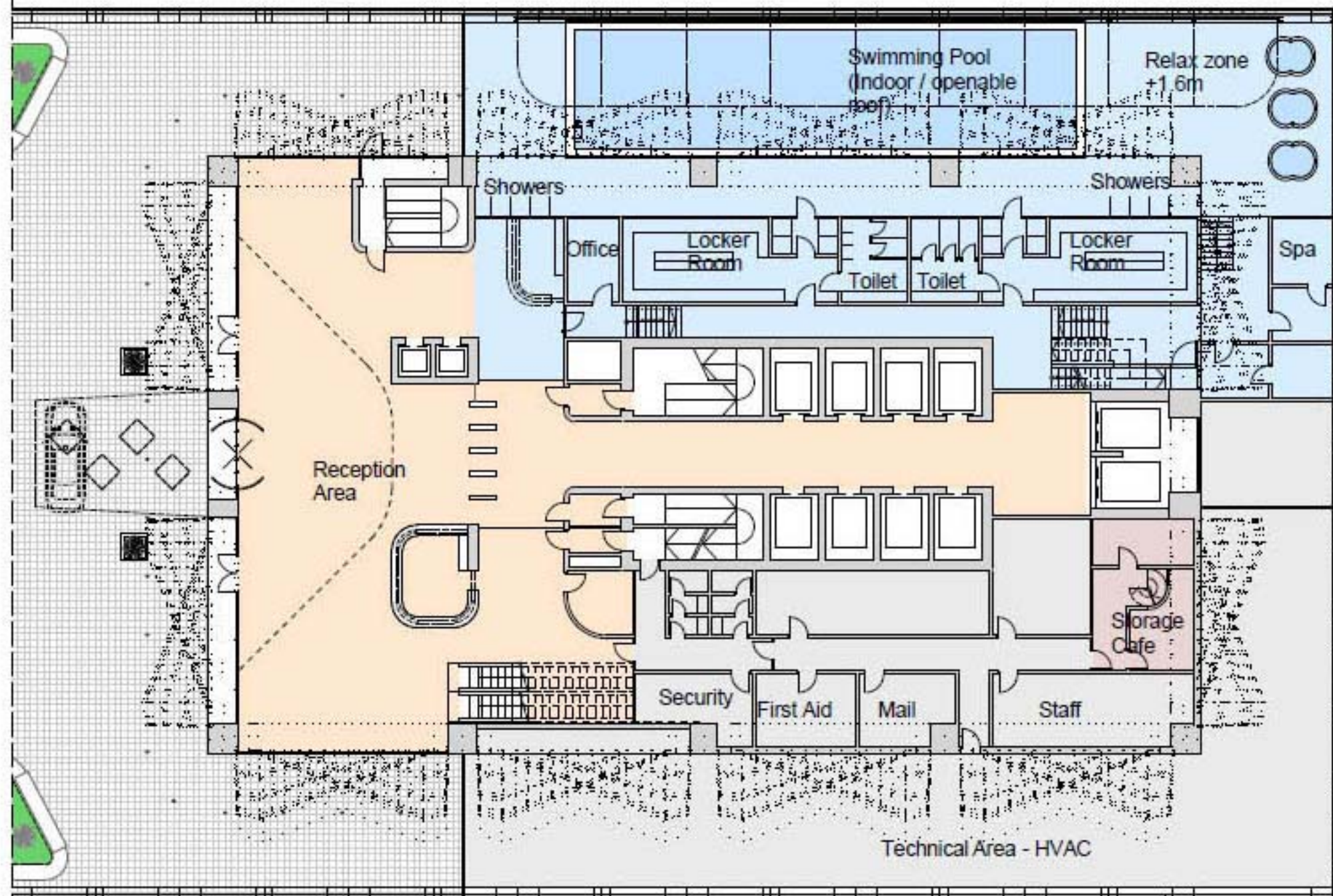

Gross Area: 2000 sqm

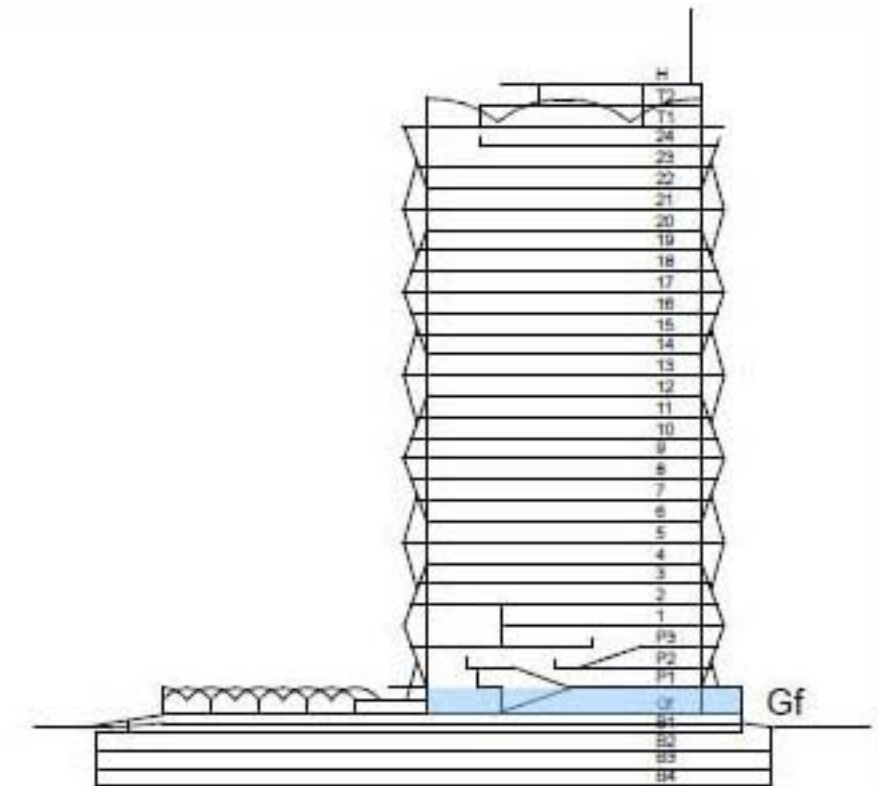

- Ground Level +1.5m**
- Floor Common Area - 450 sqm
 - Commercial Area * (Fitness & Spa) - 550sqm
 - Technical area and shafts - 580 sqm
 - Building structure
 - Car Parking places - 24covered / 6 uncovered
 - Vertical Circulation (Stairs/Elevators)
 - Escalators
 - Toilets
 - Cafe Bar 35 sqm

* Commercial Area could also be a restaurant or a firm - 2 floors

Marina Office Building
 Office Building Concept Design
 Location: Marina District, Doha, Qatar,
 Plot: Marina Com 017
 Date: Nov. 2013

Author:
 Arch. Marius-Traian Danciu
 Ecopolis Architecture Group-Bucharest

mariusdanciu.ecopolis@yahoo.com
 marius.danciu@ecopolis.ro
 tel: +40726 260424
 www.ecopolis.ro
 www.contactstudio.ro
 www.proatrium.ro



This project is the property of the Author and may not be used without his permission.

www.ecopolis.ro
 www.contactstudio.ro

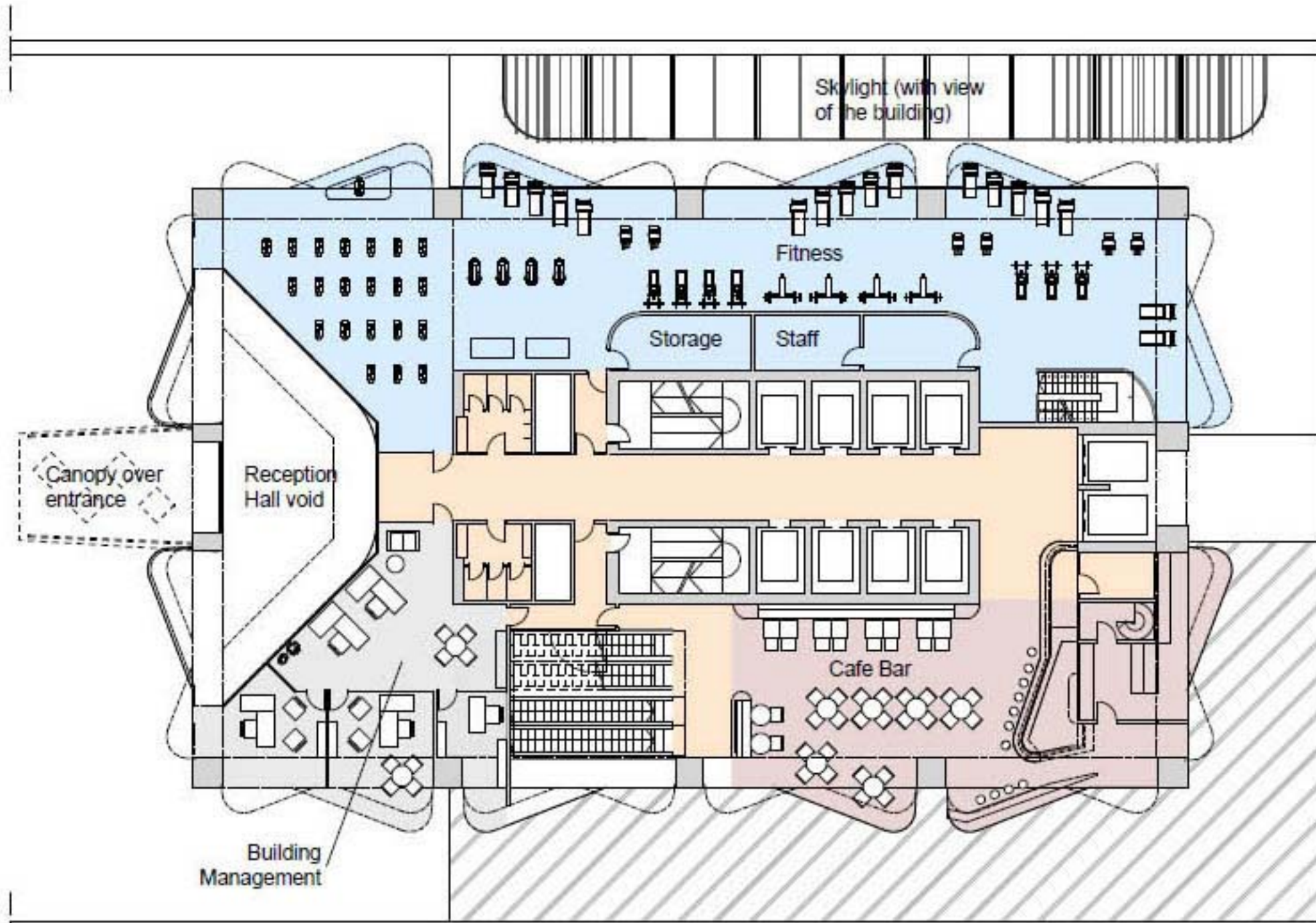

Gross Area: 1200 sqm

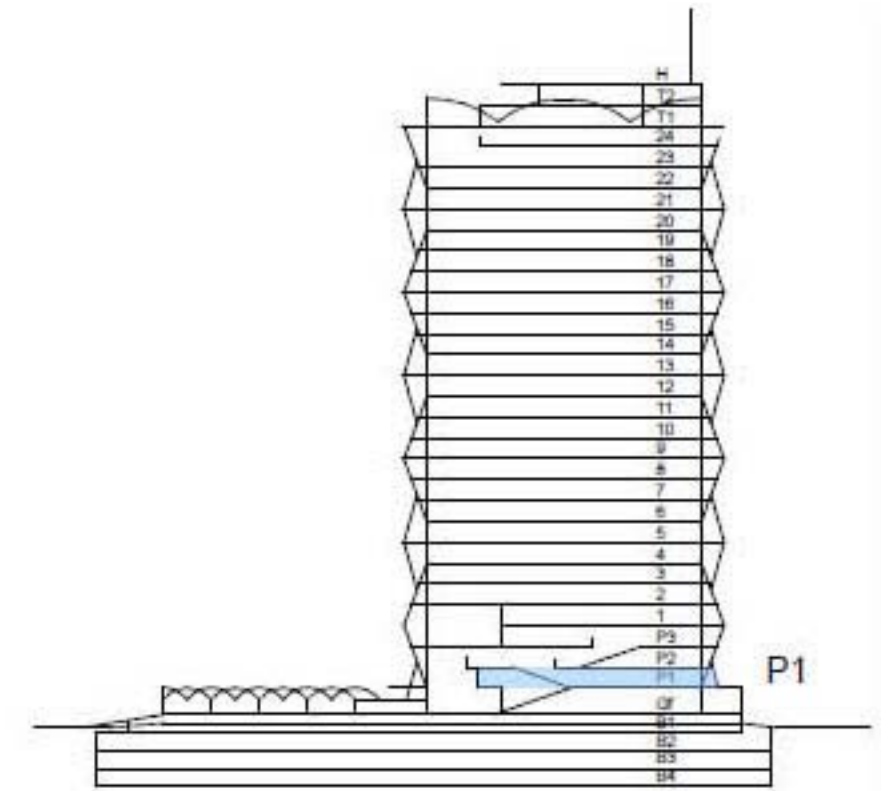

1st Floor (Plinth) - story 2

- Floor Common Area - 200 sqm
- Commercial Area * (Fitness & Spa) - 430 sqm
- Technical and Building Management - 130 sqm
- Building structure
- Vertical Circulation (Stairs/Elevators)
- Escalators
- Toilets
- Cafe Bar - 200 sqm
- Technical roof

* Commercial Area could also be a restaurant or a firm - 2 floors

Marina Office Building

Office Building Concept Design
 Location: Marina District, Doha, Qatar,
 Plot: Marina Com 017
 Date: Nov. 2013

Author:
 Arch. Marius-Traian Danciu
 Ecopolis Architecture Group-Bucharest

mariusdanciu.ecopolis@yahoo.com
 marius.danciu@ecopolis.ro
 tel: +40726 260424
 www.ecopolis.ro
 www.contactstudio.ro
 www.proatrium.ro



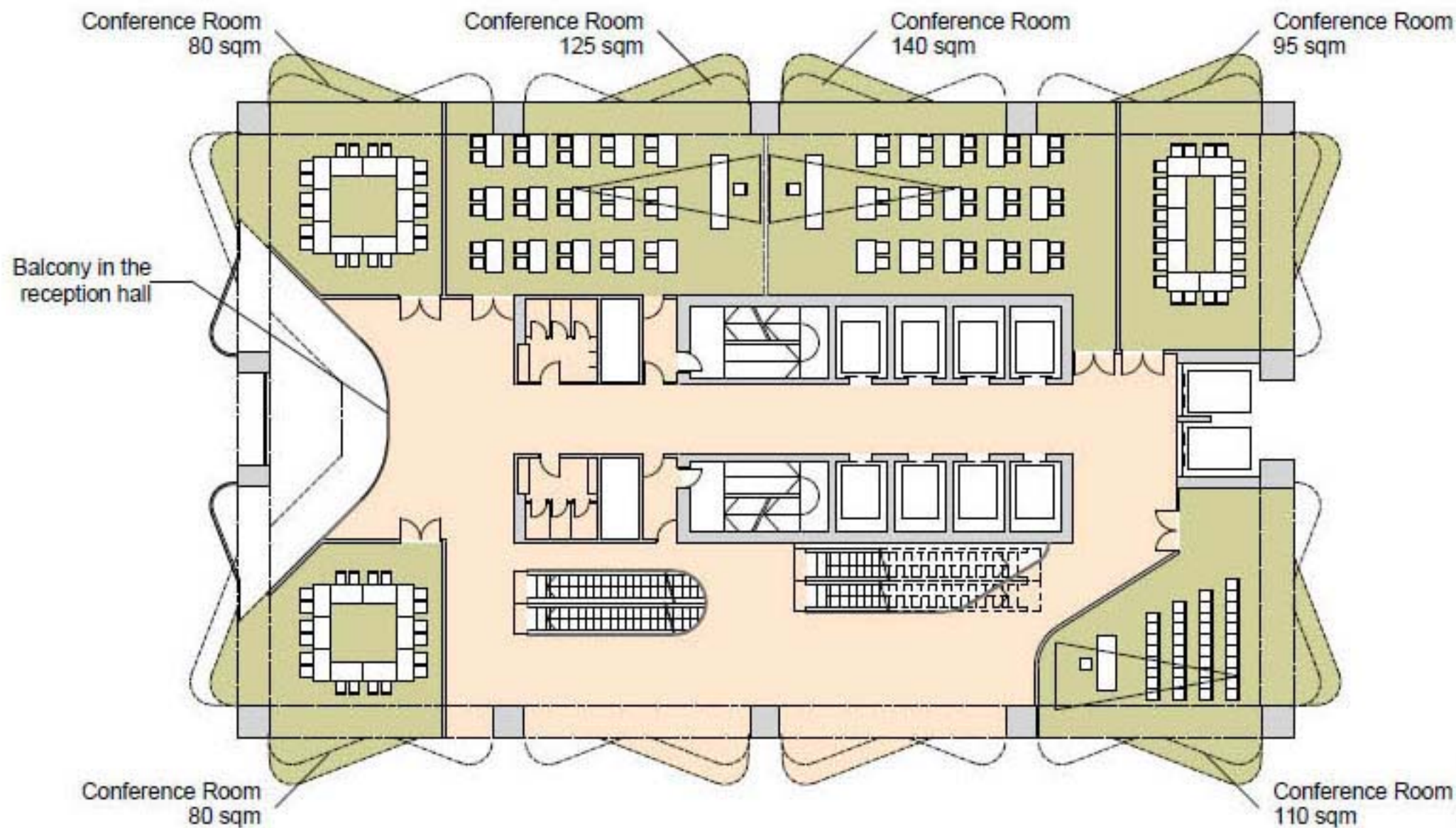

Gross Area: 1270 sqm

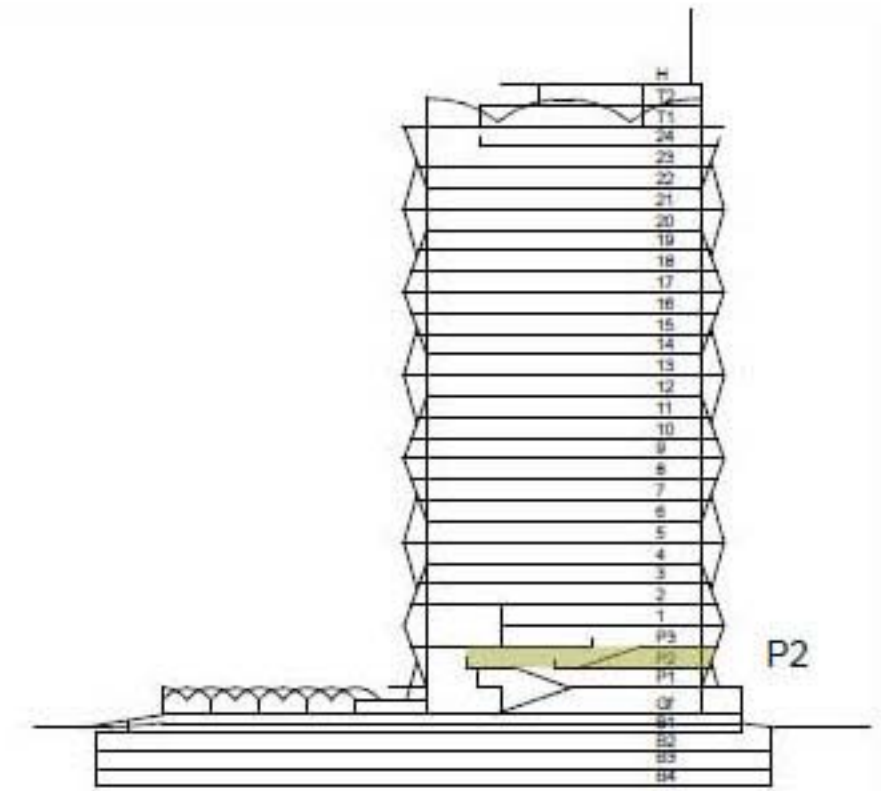
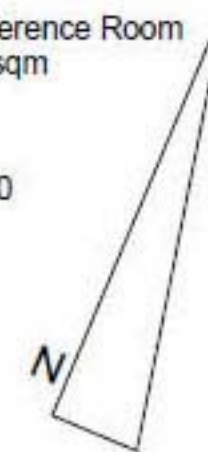
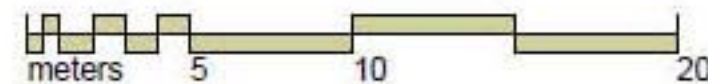

2nd Floor (Plinth) - story 3

- Floor Common Area (Lobby) - 400 sqm
- Conference rooms ** - 630 sqm
- Technical
- Building structure
- Vertical Circulation (Stairs/Elevators)
- Escalators
- Toilets

** Instead of conference rooms the entire floor could be a shop on two floors

Marina Office Building
 Office Building Concept Design
 Location: Marina District, Doha, Qatar,
 Plot: Marina Com 017
 Date: Nov. 2013

Author:
 Arch. Marius-Traian Danciu
 Ecopolis Architecture Group-Bucharest

mariusdanciu.ecopolis@yahoo.com
 marius.danciu@ecopolis.ro
 tel: +40726 260424
 www.ecopolis.ro
 www.contactstudio.ro
 www.proatrium.ro

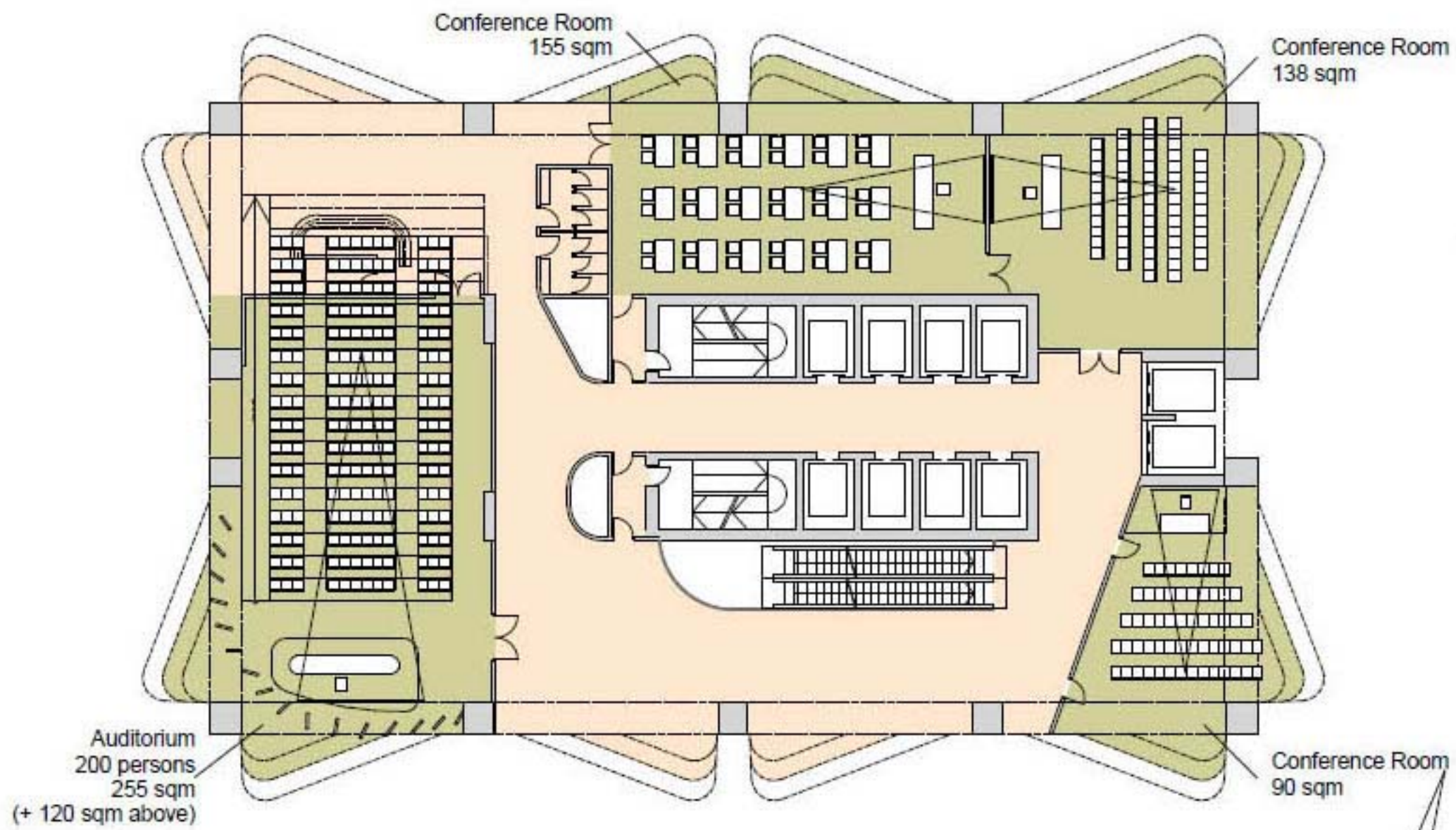

Gross Area: 1340 sqm

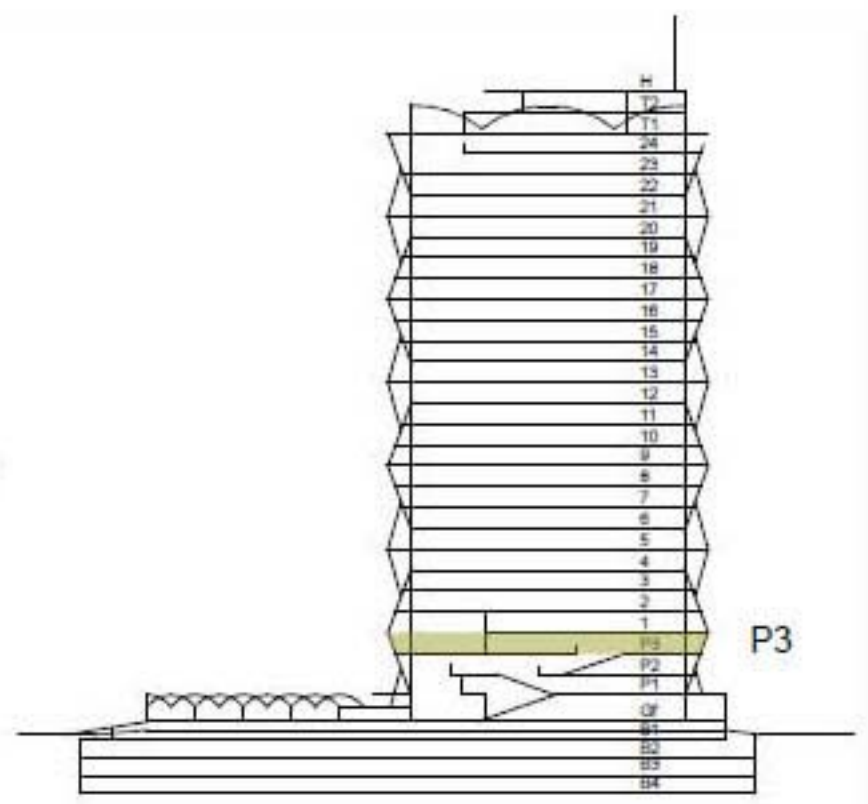

3rd Floor (Plinth) - story 4

- Floor Common Area (Lobby) - 481 sqm
- Conference rooms ** - 640 sqm
- Technical
- Building structure
- Vertical Circulation (Stairs/Elevators)
- Escalators
- Toilets

** Instead of conference rooms the entire floor could be a shop on two floors

Marina Office Building
 Office Building Concept Design
 Location: Marina District, Doha, Qatar,
 Plot: Marina Com 017
 Date: Nov. 2013

Author:
 Arch. Marius-Traian Danciu
 Ecopolis Architecture Group-Bucharest

mariusdanciu.ecopolis@yahoo.com
 marius.danciu@ecopolis.ro
 tel: +40726 260424
 www.ecopolis.ro
 www.contactstudio.ro
 www.proatrium.ro

Conference Room
120 sqm
(+ 255 sqm below)

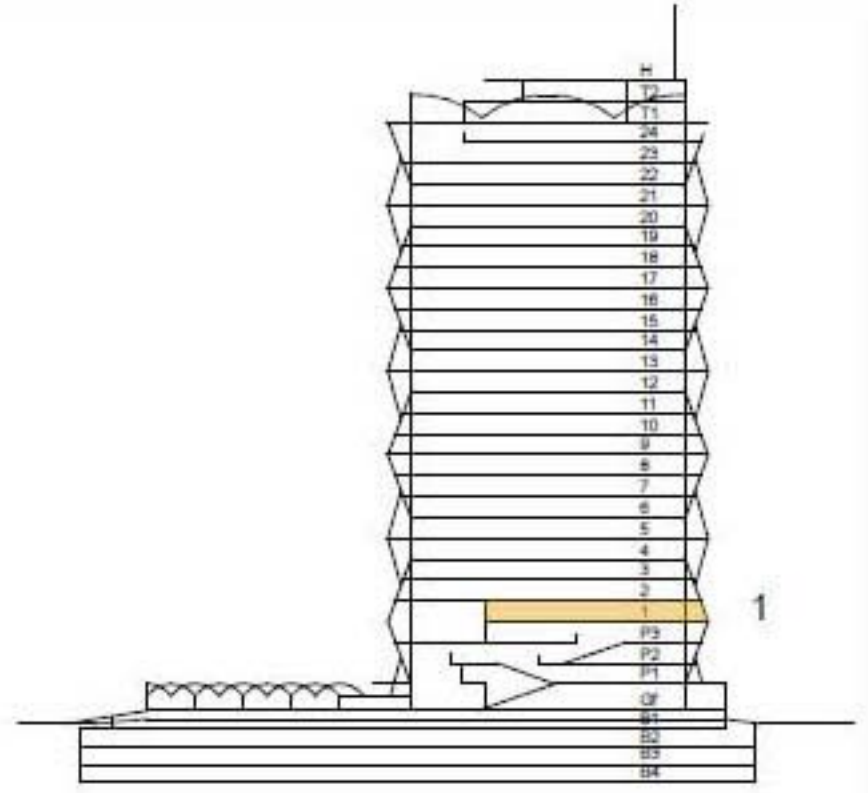
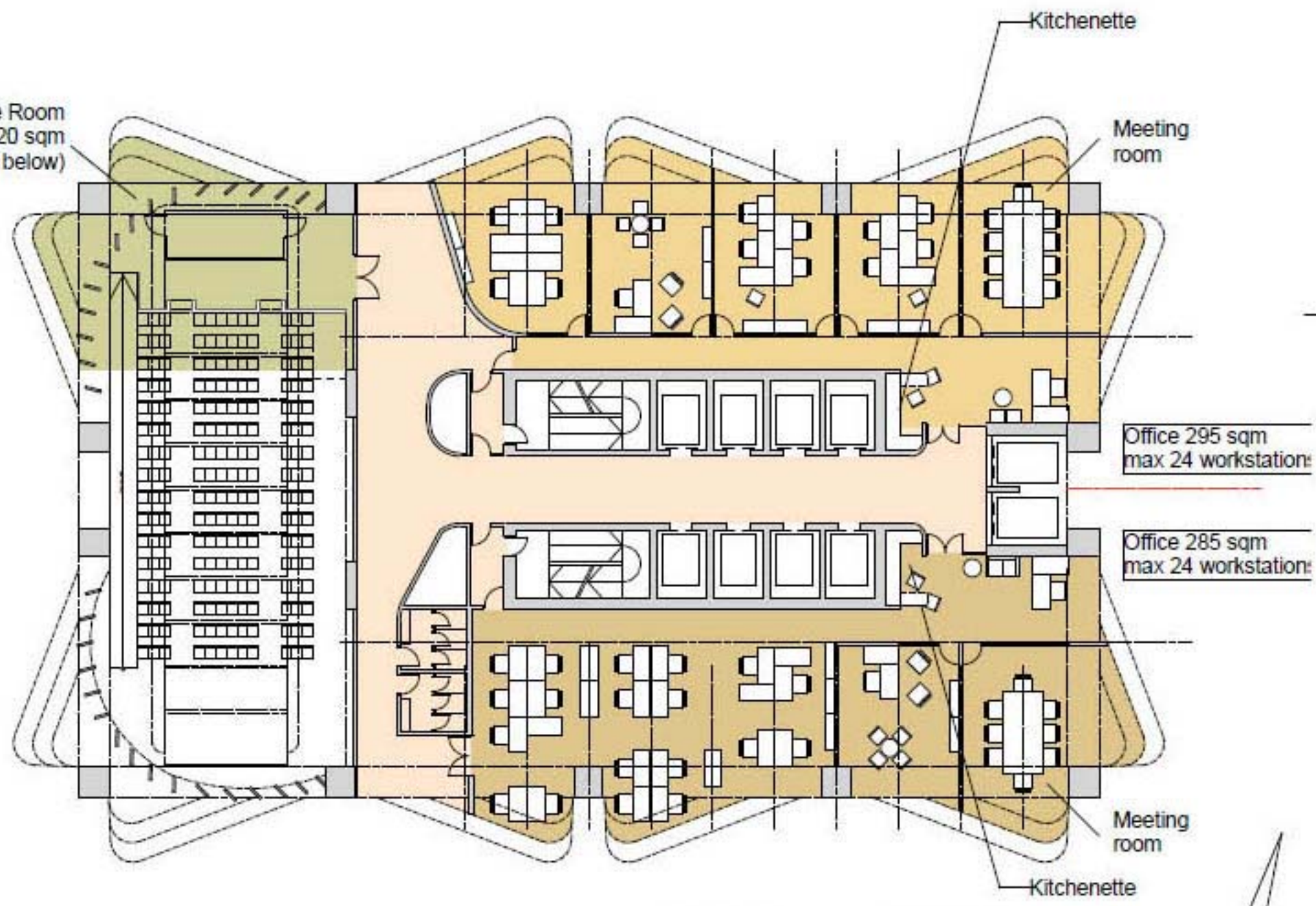

- 1st Floor (Office) - story 5**
- Floor Common Area (Lift Lobby) - 215 sqm
 - Office - Direct rentable area
 - Conference room (2nd level)
 - Technical
 - Building structure
 - Vertical Circulation (Stairs/Elevators)
 - Escalators
 - Toilets

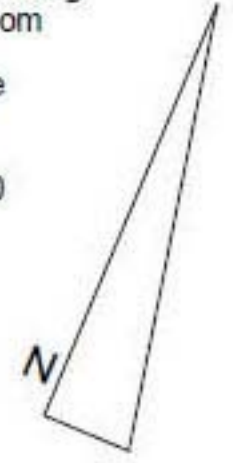
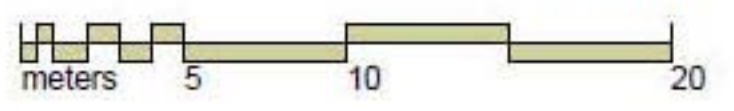

Gross Area: 1090 sqm

Marina Office Building
Office Building Concept Design
Location: Marina District, Doha, Qatar,
Plot: Marina Com 017
Date: Nov. 2013

Author:
Arch. Marius-Traian Danciu
Ecopolis Architecture Group-Bucharest

mariusdanciu.ecopolis@yahoo.com
marius.danciu@ecopolis.ro
tel: +40726 260424
www.ecopolis.ro
www.contactstudio.ro
www.proatrium.ro



This project is the property of the Author and may not be used without his permission.

www.ecopolis.ro
www.contactstudio.ro

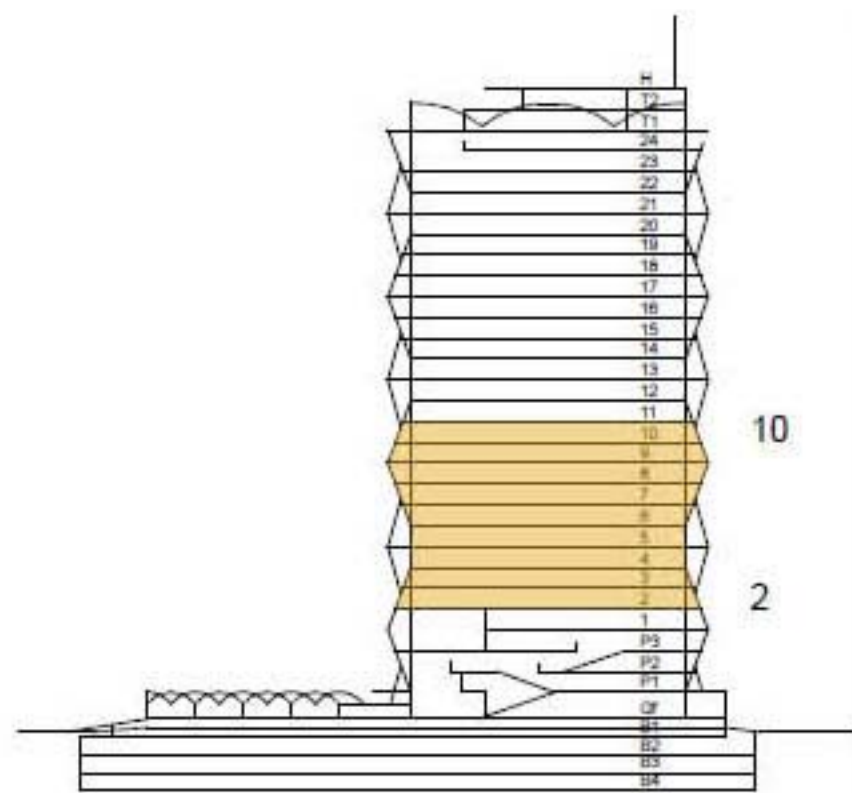
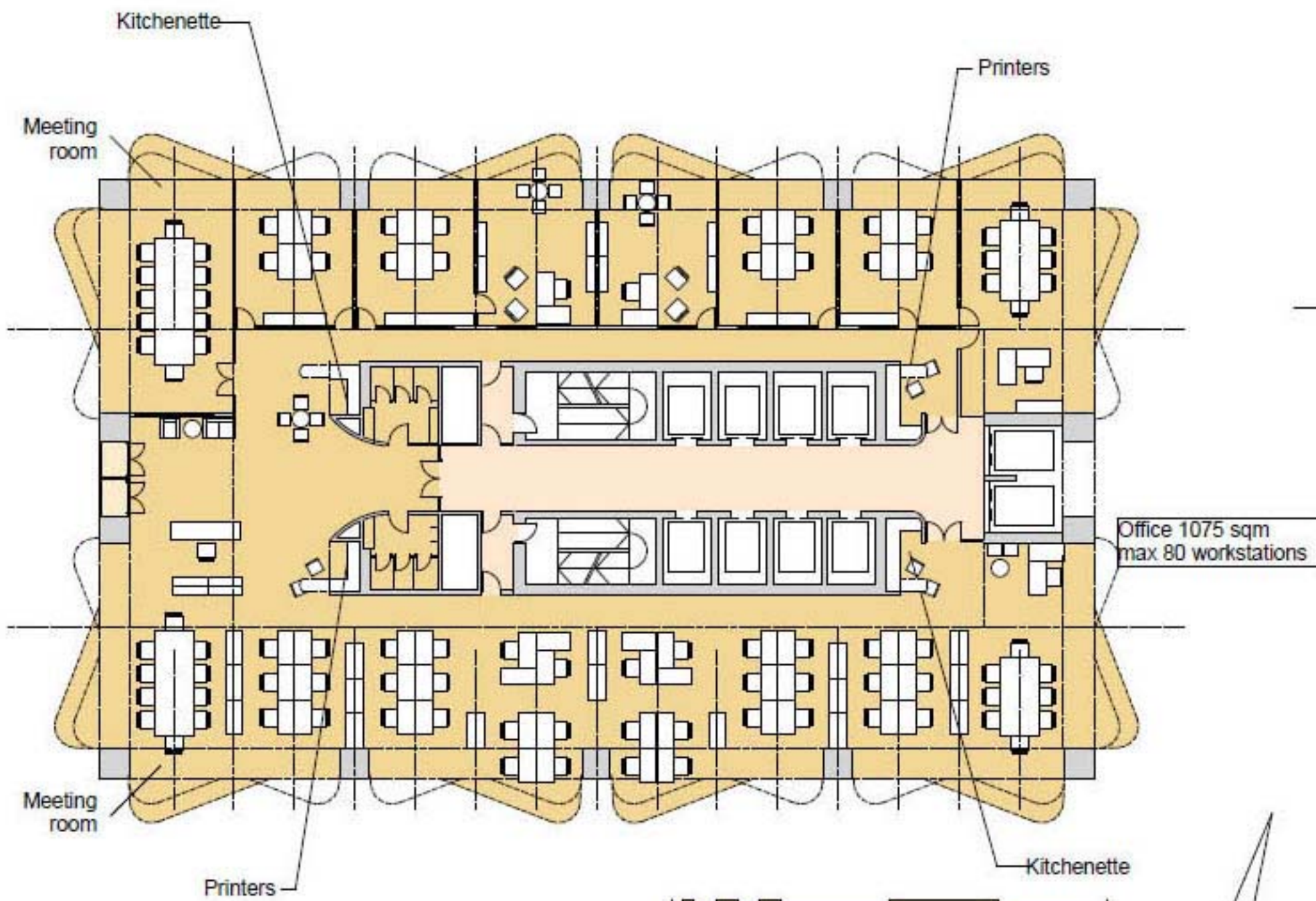

2nd .. 10th Floor (Office) -
 story 6 .. 14
 1 tenant / floor

- Floor Common Area (Lift Lobby) - 100 sqm
- Office - Direct rentable area - 1075 sqm
- Technical
- Building structure
- Vertical Circulation (Stairs/Elevators)
- Toilets

Gross Area: 1340 sqm

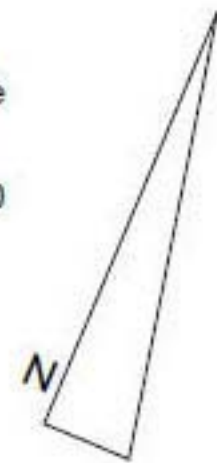
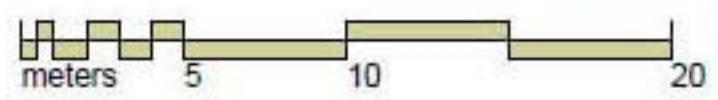

This project is the property of the Author and may not be used without his permission.

Marina Office Building
 Office Building Concept Design
 Location: Marina District, Doha, Qatar,
 Plot: Marina Com 017
 Date: Nov. 2013
 Author:
 Arch. Marius-Traian Danciu
 Ecopolis Architecture Group-Bucharest
 mariusdanciu.ecopolis@yahoo.com
 marius.danciu@ecopolis.ro
 tel: +40726 260424
 www.ecopolis.ro
 www.contactstudio.ro
 www.proatrium.ro

www.ecopolis.ro
 www.contactstudio.ro

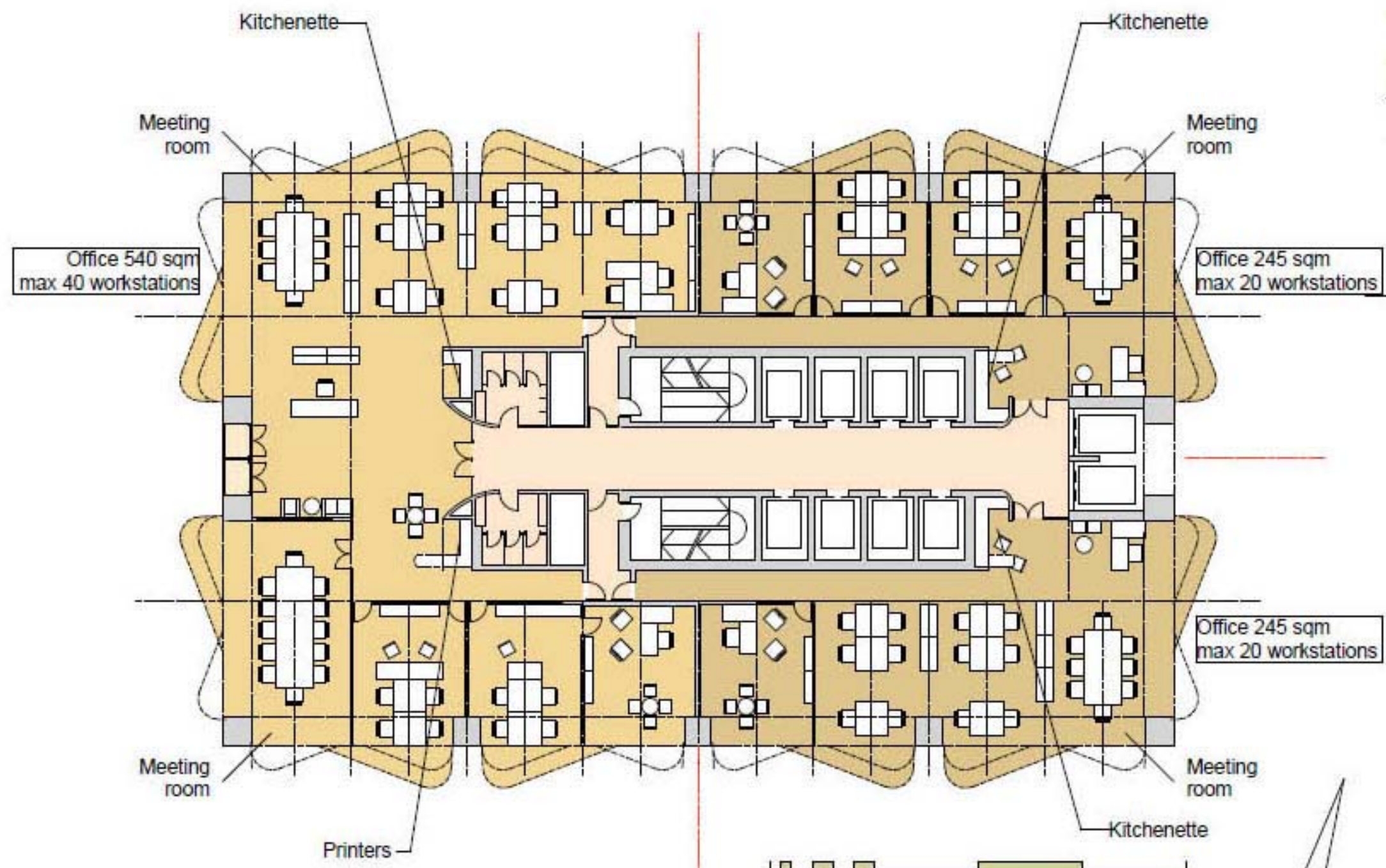

Office 540 sqm
max 40 workstations

Office 245 sqm
max 20 workstations

Office 245 sqm
max 20 workstations

Gross Area: 1340 sqm

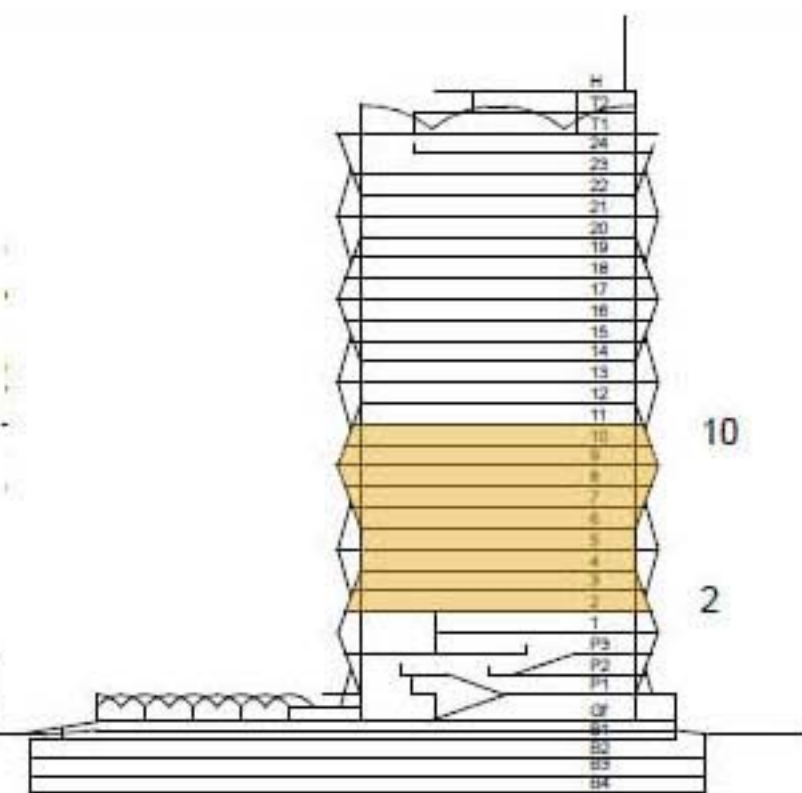
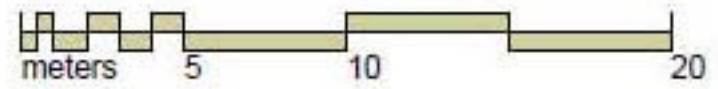

2nd .. 11th Floor (Office) -
story 5 .. 14
3 tenants /floor

- Floor Common Area (Lift Lobby) - 145 sqm
- Office - Direct rentable area - 1030 sqm
- Technical
- Building structure
- Vertical Circulation (Stairs/Elevators)
- Toilets

Marina Office Building
 Office Building Concept Design
 Location: Marina District, Doha, Qatar,
 Plot: Marina Com 017
 Date: Nov. 2013
 Author:
 Arch. Marius-Traian Danciu
 Ecopolis Architecture Group-Bucharest
 mariusdanciu.ecopolis@yahoo.com
 marius.danciu@ecopolis.ro
 tel: +40726 260424
 www.ecopolis.ro
 www.contactstudio.ro
 www.proatrium.ro



This project is the property of the Author and may not be used without his permission.

www.ecopolis.ro
www.contactstudio.ro

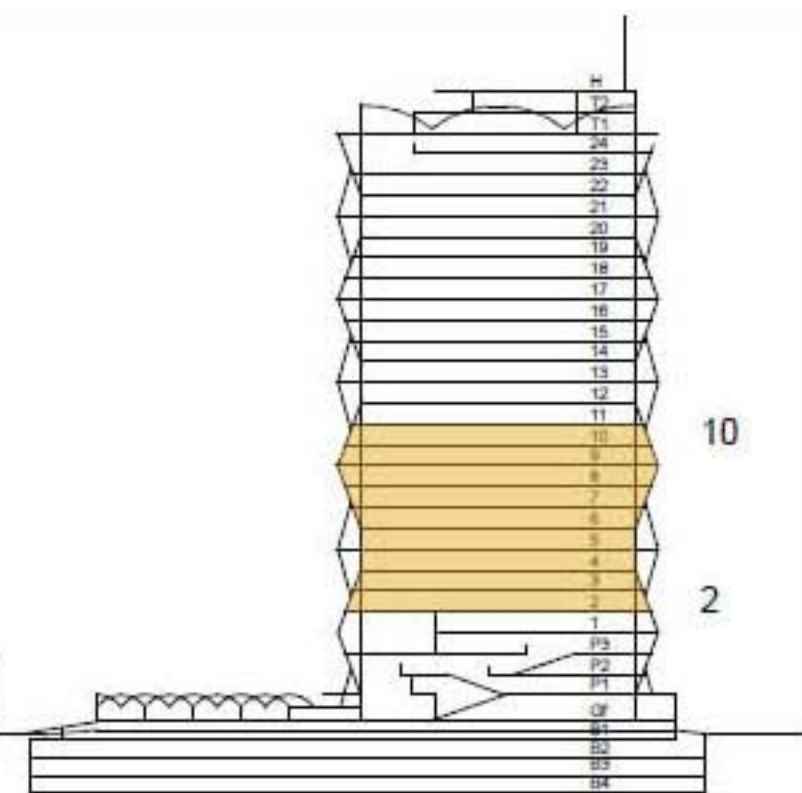

2nd .. 11th Floor (Office) -
 story 5 .. 14
 2 tenants /floor

- Floor Common Area (Lift Lobby) - 135 s
- Office - Direct rentable area - 1040 sqm
- Technical
- Building structure
- Vertical Circulation (Stairs/Elevators)
- Toilets

Gross Area: 1340 sqm

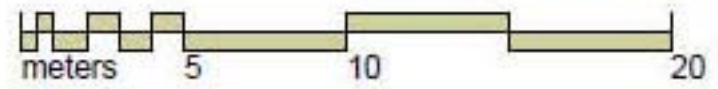

This project is the property of the Author and may not be used without his permission.

Marina Office Building
 Office Building Concept Design
 Location: Marina District, Doha, Qatar,
 Plot: Marina Com 017
 Date: Nov. 2013

Author:
 Arch. Marius-Traian Danciu
 Ecopolis Architecture Group-Bucharest

mariusdanciu.ecopolis@yahoo.com
 marius.danciu@ecopolis.ro
 tel: +40726 260424
 www.ecopolis.ro
 www.contactstudio.ro
 www.proatrium.ro

www.ecopolis.ro
 www.contactstudio.ro

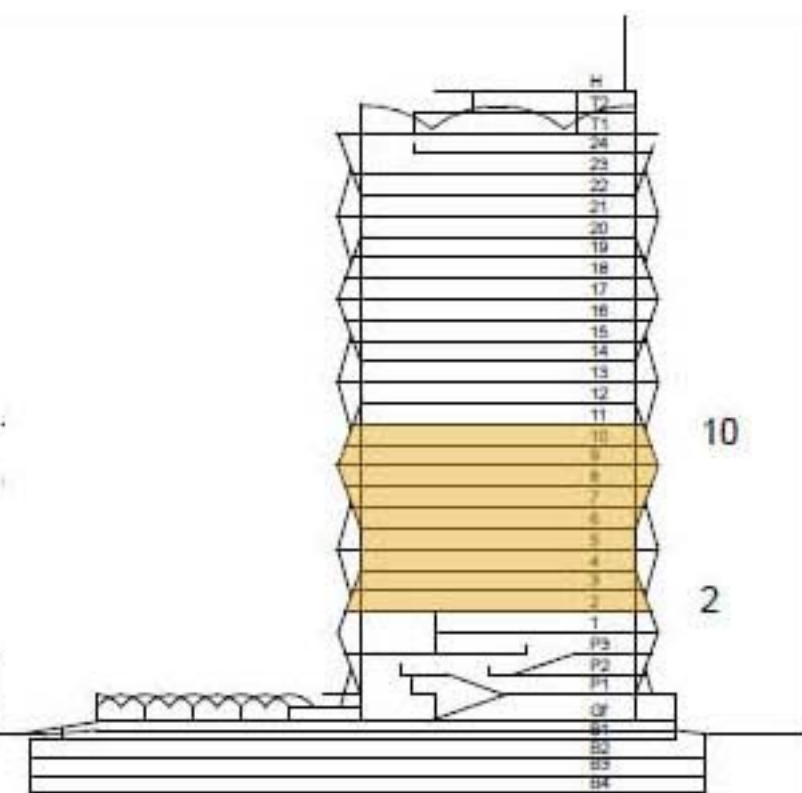
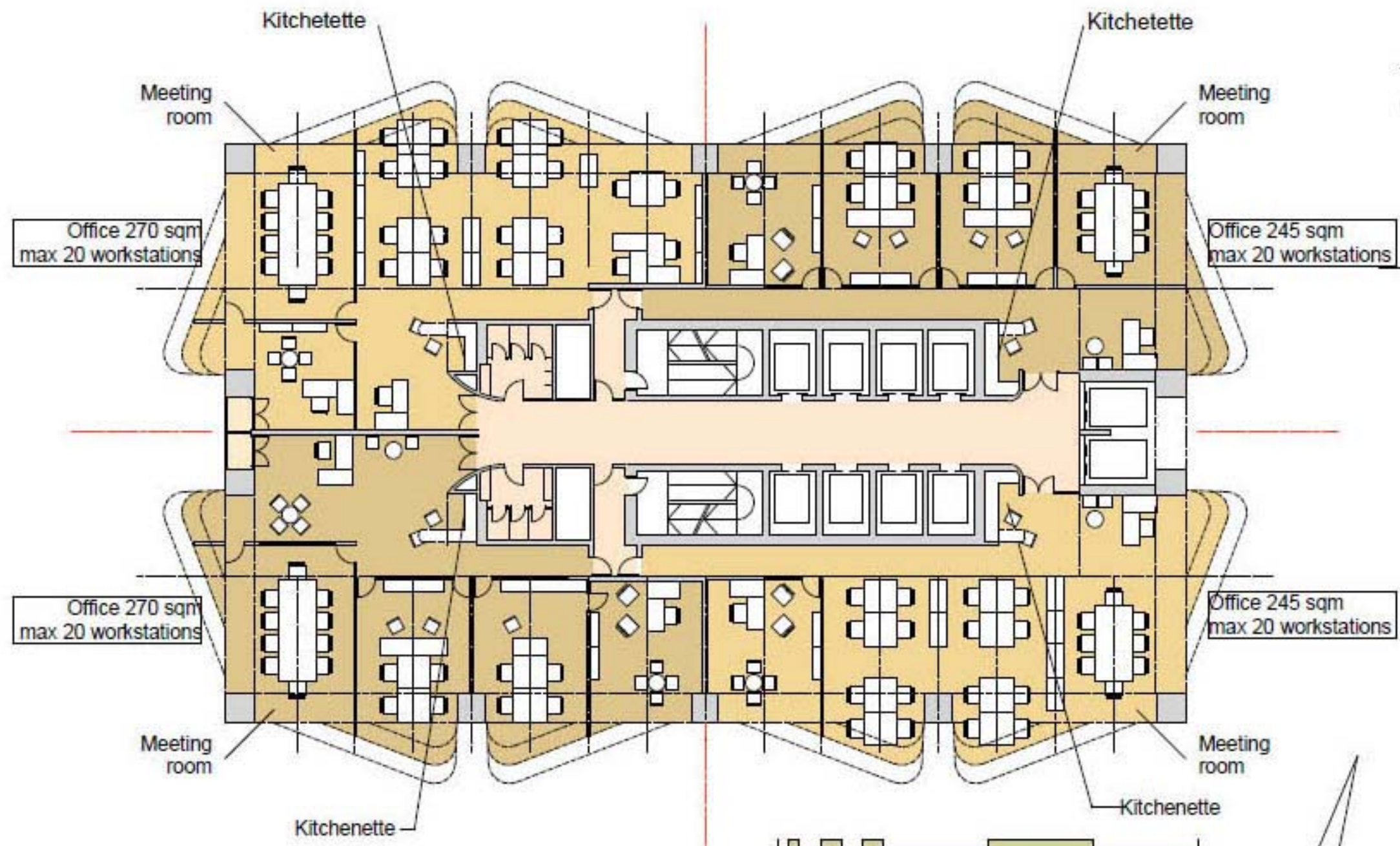

- 2nd .. 11th Floor (Office) -
 story 5 .. 14
 4 tenants /floor
- Floor Common Area (Lift Lobby) - 145sqm
 - Office - Direct rentable area - 1030 sqm
 - Technical
 - Building structure
 - Vertical Circulation (Stairs/Elevators)
 - Toilets

Office 270 sqm
max 20 workstations

Office 245 sqm
max 20 workstations

Office 245 sqm
max 20 workstations

Gross Area: 1340 sqm

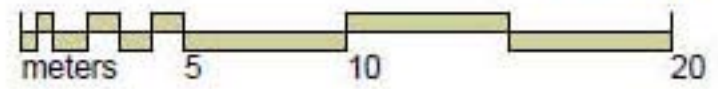

This project is the property of the Author and may not be used without his permission.

Marina Office Building
 Office Building Concept Design
 Location: Marina District, Doha, Qatar,
 Plot: Marina Com 017
 Date: Nov. 2013

Author:
 Arch. Marius-Traian Danciu
 Ecopolis Architecture Group-Bucharest

mariusdanciu.ecopolis@yahoo.com
 marius.danciu@ecopolis.ro
 tel: +40726 260424
 www.ecopolis.ro
 www.contactstudio.ro
 www.proatrium.ro

www.ecopolis.ro
 www.contactstudio.ro

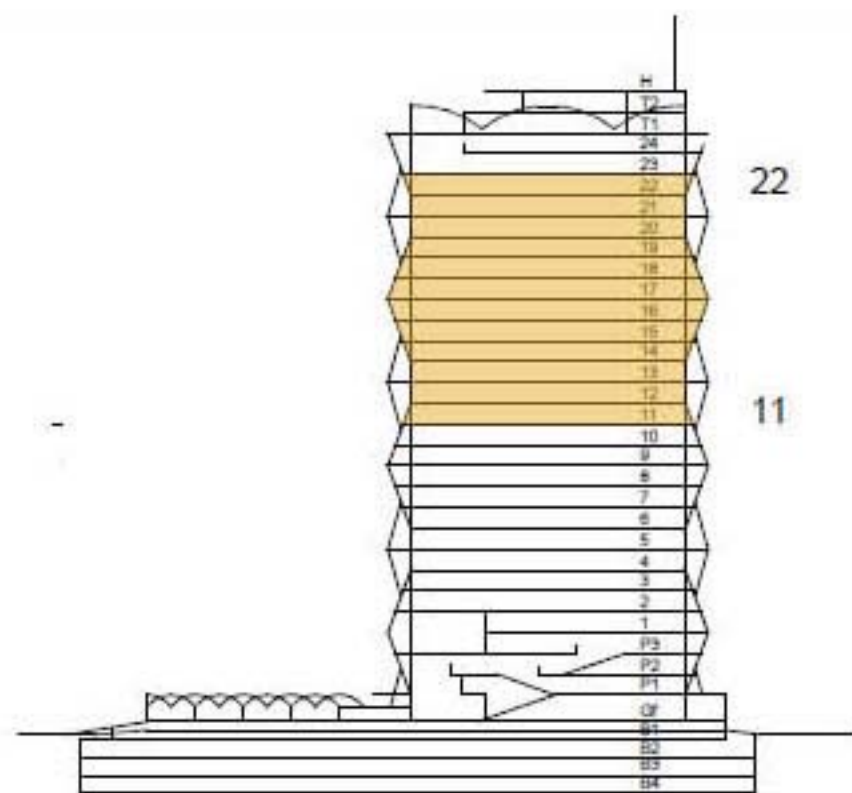
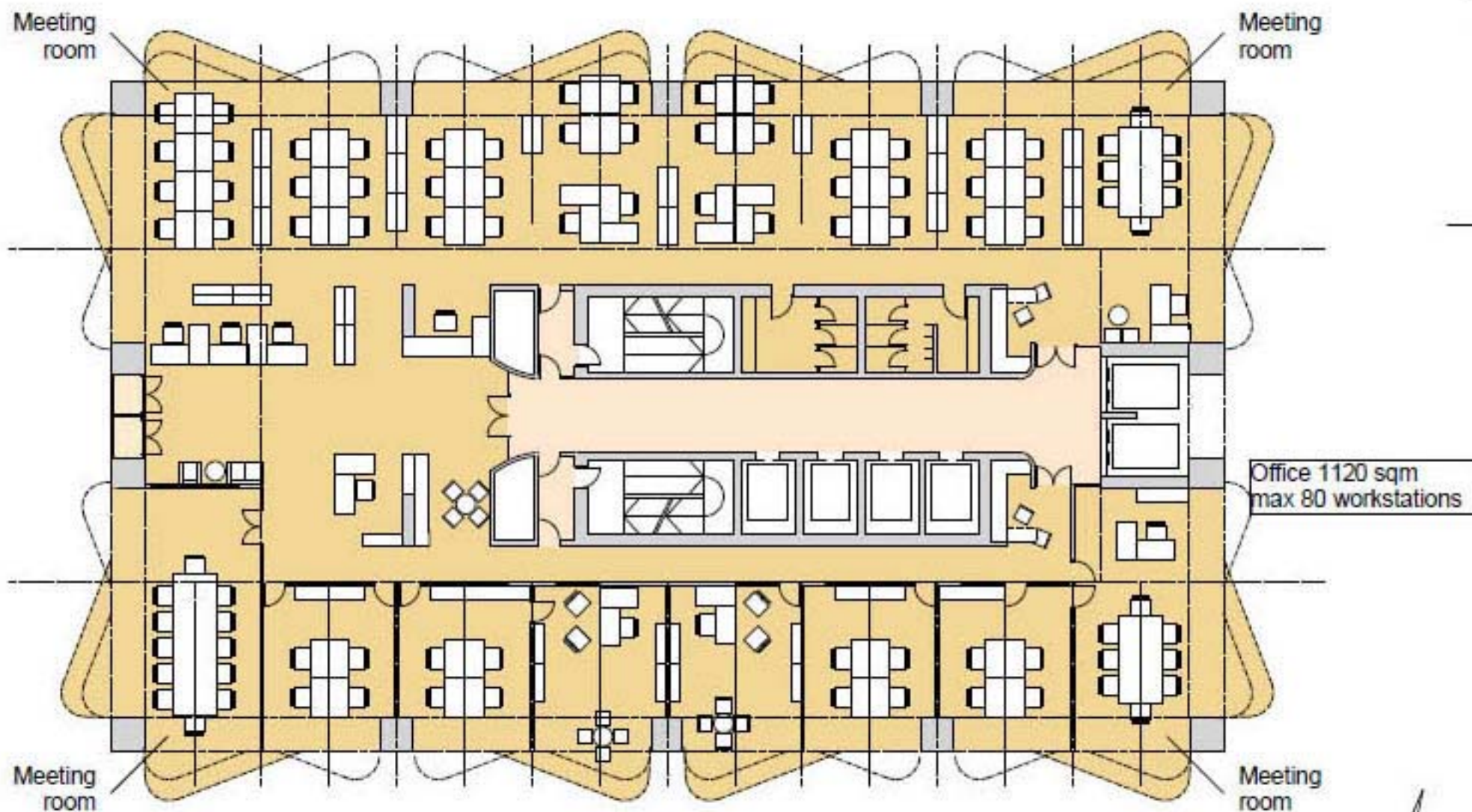

11th .. 22rd Floor (Office) -
 story 15 .. 26
 1 tenant /floor

- Floor Common Area (Lift Lobby) - 100 sqm
- Office - Direct rentable area - 1120 sqm
- Technical
- Building structure
- Vertical Circulation (Stairs/Elevators)
- Toilets

Gross Area: 1340 sqm

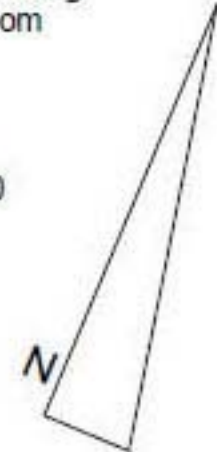
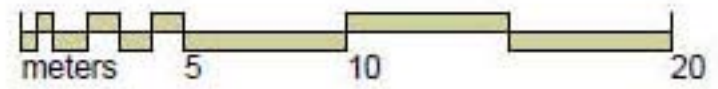

Marina Office Building
 Office Building Concept Design
 Location: Marina District, Doha, Qatar,
 Plot: Marina Com 017
 Date: Nov. 2013

Author:
 Arch. Marius-Traian Danciu
 Ecopolis Architecture Group-Bucharest

mariusdanciu.ecopolis@yahoo.com
 marius.danciu@ecopolis.ro
 tel: +40726 260424
 www.ecopolis.ro
 www.contactstudio.ro
 www.proatrium.ro

This project is the property of the Author and may not be used without his permission.

www.ecopolis.ro
 www.contactstudio.ro

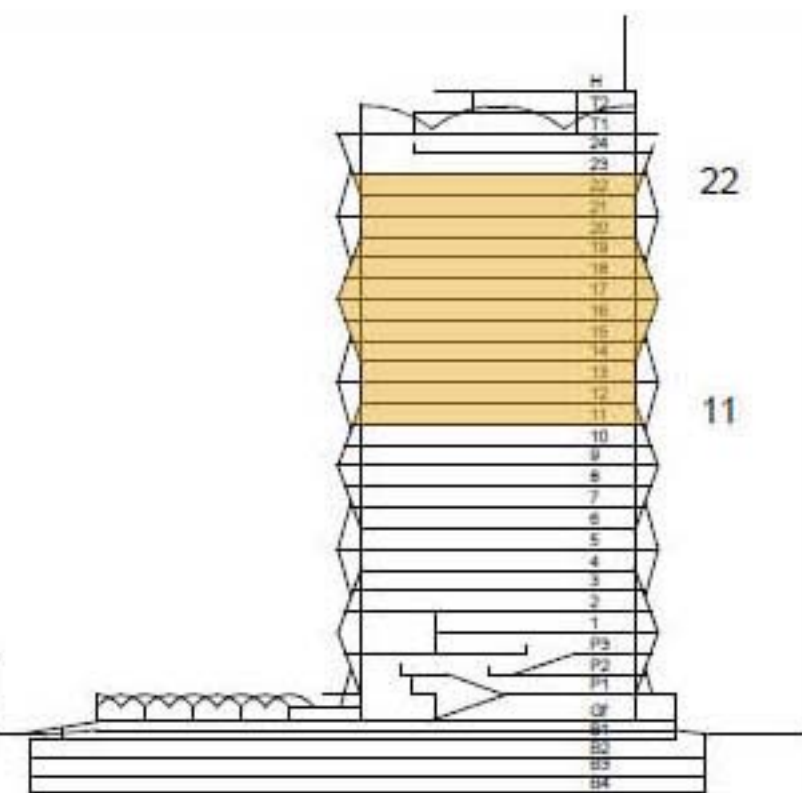
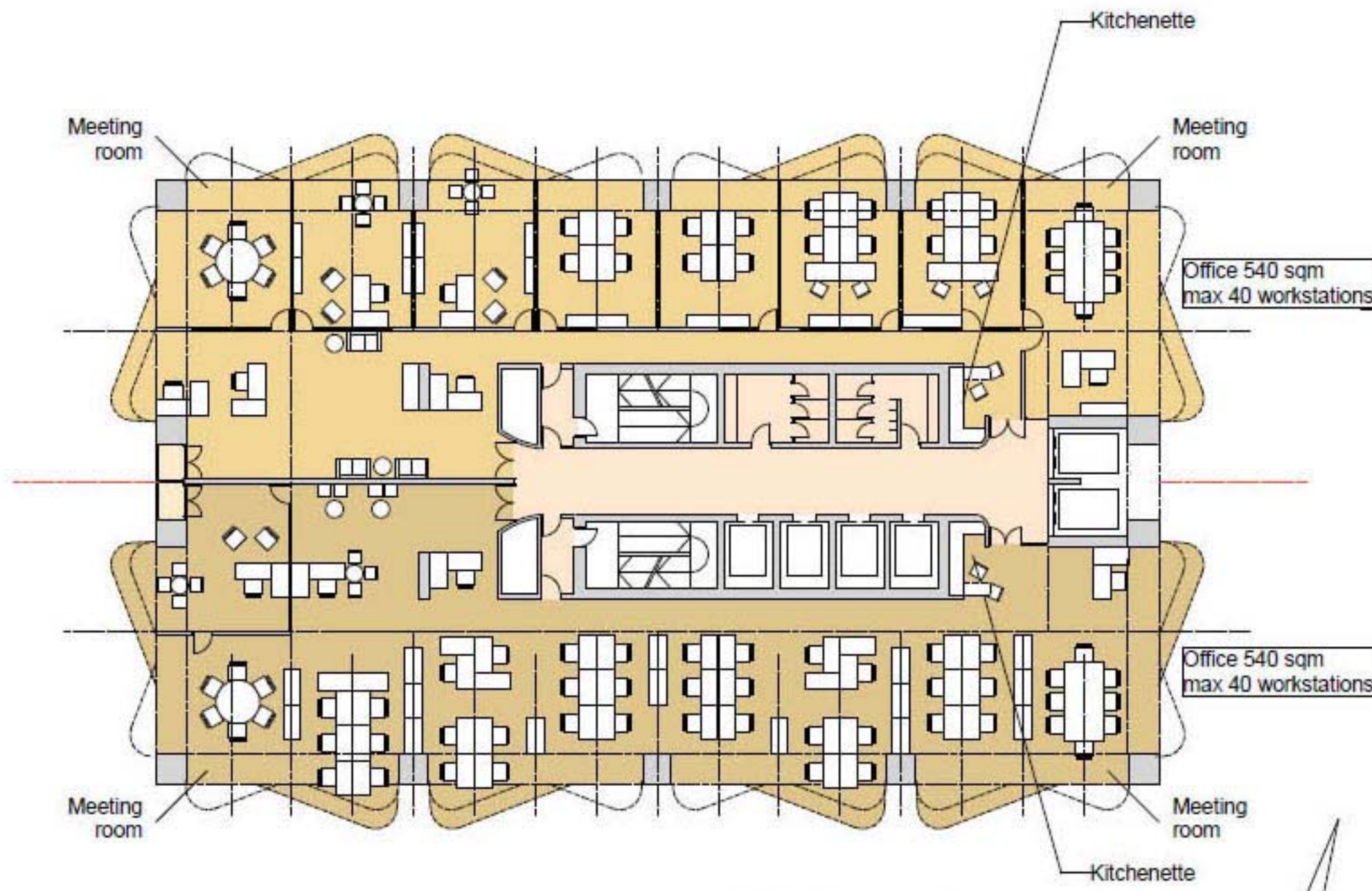

11th .. 22rd Floor (Office) -
 story 15 .. 26
 2 tenants /floor

- Floor Common Area (Lift Lobby) - 130 sqm
- Office - Direct rentable area - 1080 sqm
- Technical
- Building structure
- Vertical Circulation (Stairs/Elevators)
- Toilets

Gross Area: 1340 sqm

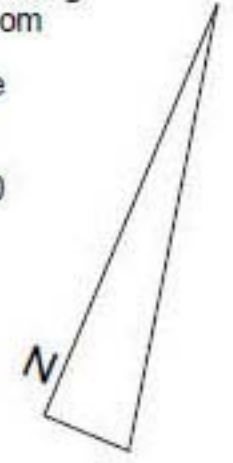
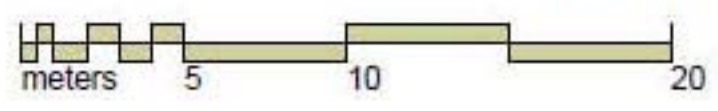

This project is the property of the Author and may not be used without his permission.

Marina Office Building
 Office Building Concept Design
 Location: Marina District, Doha, Qatar,
 Plot: Marina Com 017
 Date: Nov. 2013

Author:
 Arch. Marius-Traian Danciu
 Ecopolis Architecture Group-Bucharest

mariusdanciu.ecopolis@yahoo.com
 marius.danciu@ecopolis.ro
 tel: +40726 260424
 www.ecopolis.ro
 www.contactstudio.ro
 www.proatrium.ro

www.ecopolis.ro
 www.contactstudio.ro

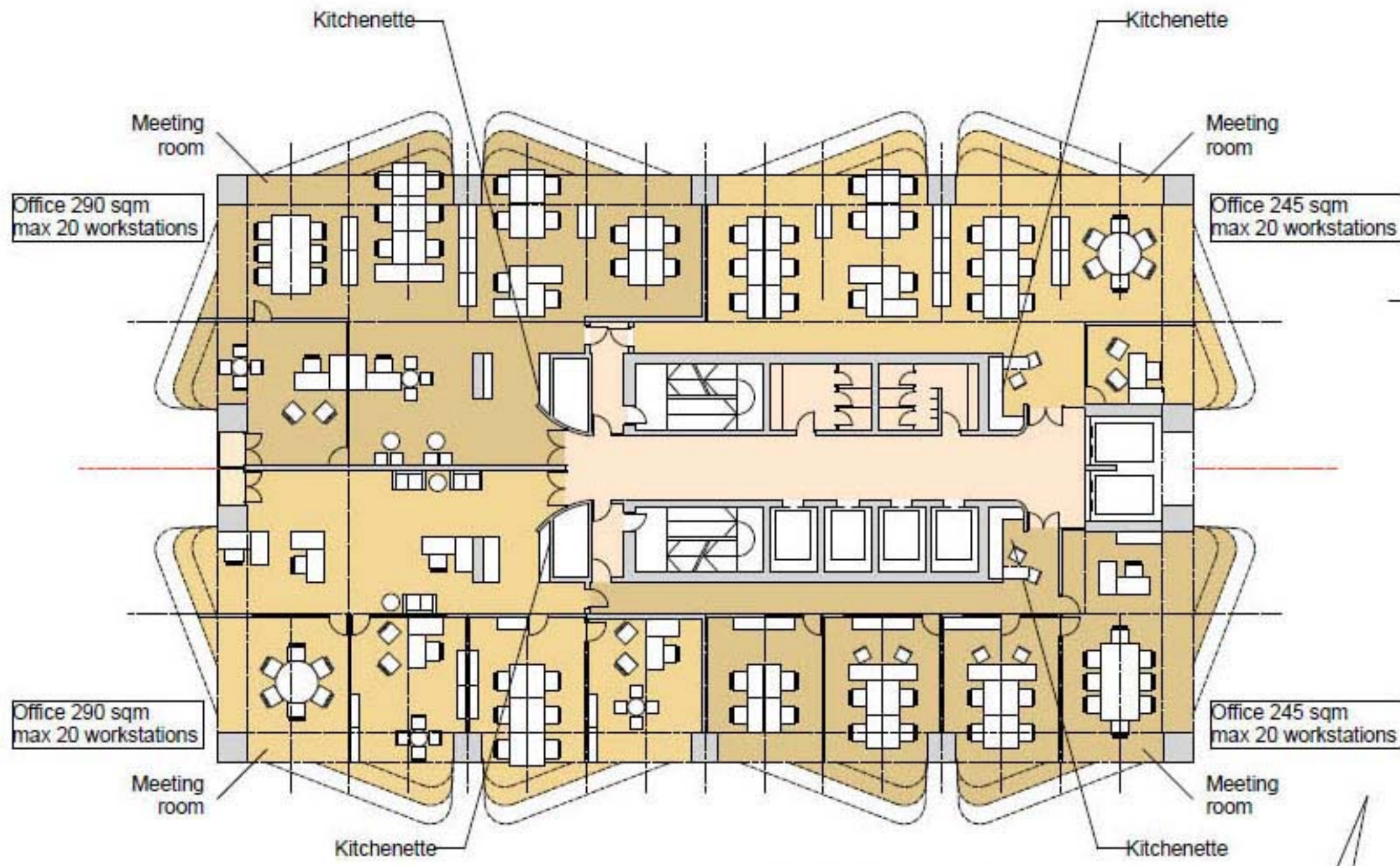

Office 290 sqm
max 20 workstations

Office 245 sqm
max 20 workstations

Office 290 sqm
max 20 workstations

Office 245 sqm
max 20 workstations

Gross Area: 1340 sqm

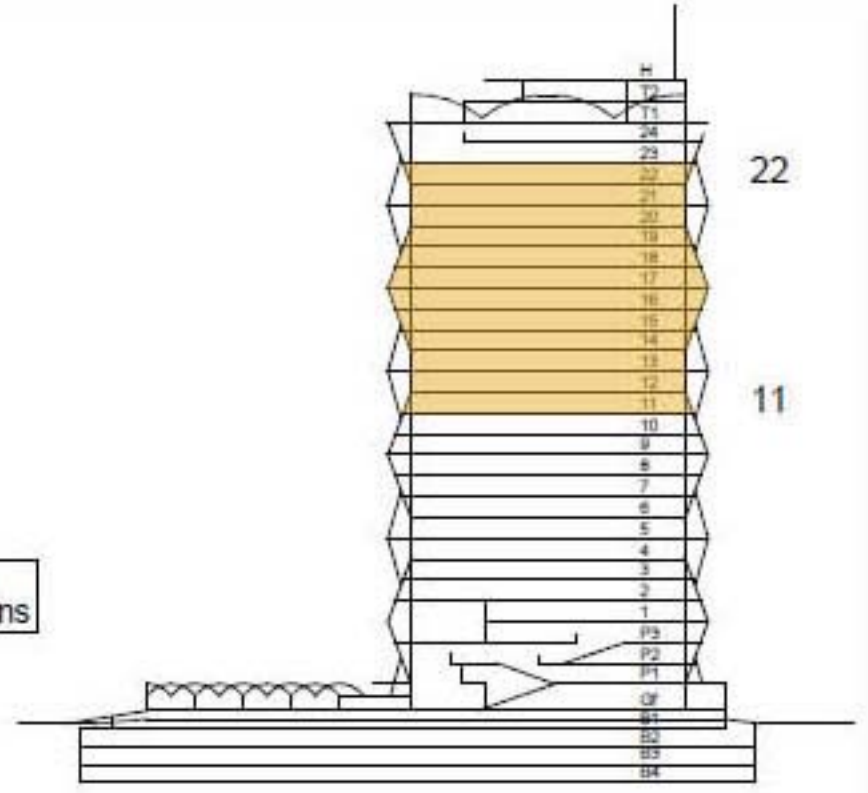
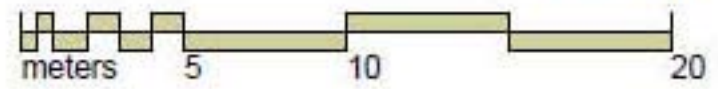

11th .. 22rd Floor (Office) -
story 15 .. 26
4 tenants /floor

- Floor Common Area (Lift Lobby) - 140 sqm
- Office - Direct rentable area - 1070 sqm
- Technical
- Building structure
- Vertical Circulation (Stairs/Elevators)
- Toilets

Marina Office Building
 Office Building Concept Design
 Location: Marina District, Doha, Qatar,
 Plot: Marina Com 017
 Date: Nov. 2013
 Author:
 Arch. Marius-Traian Danciu
 Ecopolis Architecture Group-Bucharest
 mariusdanciu.ecopolis@yahoo.com
 marius.danciu@ecopolis.ro
 tel: +40726 260424
 www.ecopolis.ro
 www.contactstudio.ro
 www.proatrium.ro



This project is the property of the Author and may not be used without his permission.

www.ecopolis.ro
www.contactstudio.ro

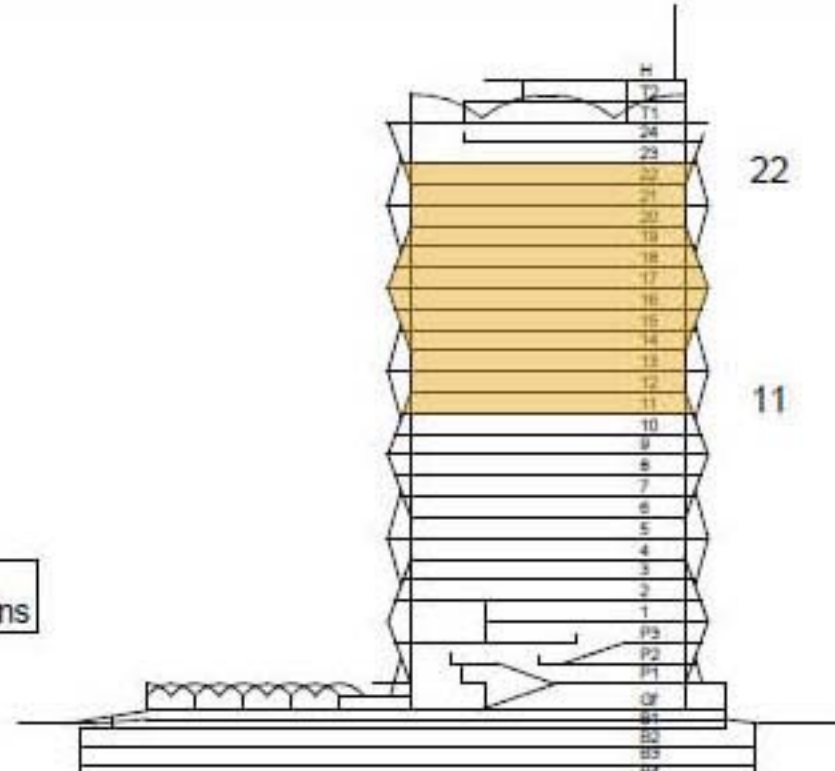
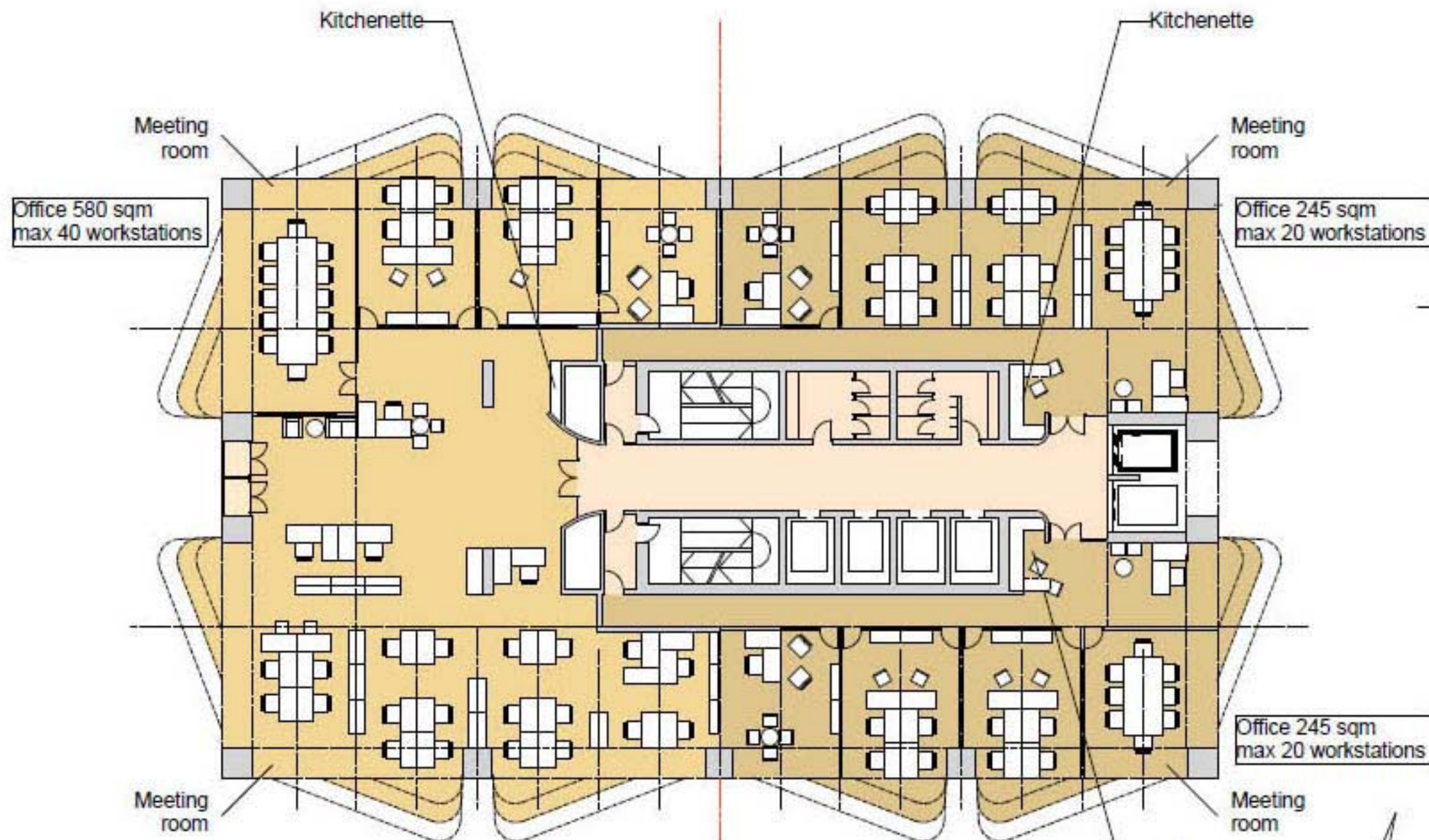

11th .. 22rd Floor (Office) -
 story 15 .. 26
 3 tenants /floor

- Floor Common Area (Lift Lobby) - 140 sqm
- Office - Direct rentable area - 1070 sqm
- Technical
- Building structure
- Vertical Circulation (Stairs/Elevators)
- Toilets

Office 245 sqm
 max 20 workstations

Gross Area: 1340 sqm

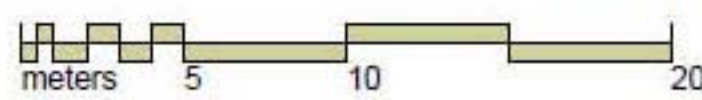

Marina Office Building
 Office Building Concept Design
 Location: Marina District, Doha, Qatar,
 Plot: Marina Com 017
 Date: Nov. 2013

Author:
 Arch. Marius-Traian Danciu
 Ecopolis Architecture Group-Bucharest

mariusdanciu.ecopolis@yahoo.com
 marius.danciu@ecopolis.ro
 tel: +40726 260424
 www.ecopolis.ro
 www.contactstudio.ro
 www.proatrium.ro

This project is the property of the Author and may not be used without his permission.

www.ecopolis.ro
 www.contactstudio.ro

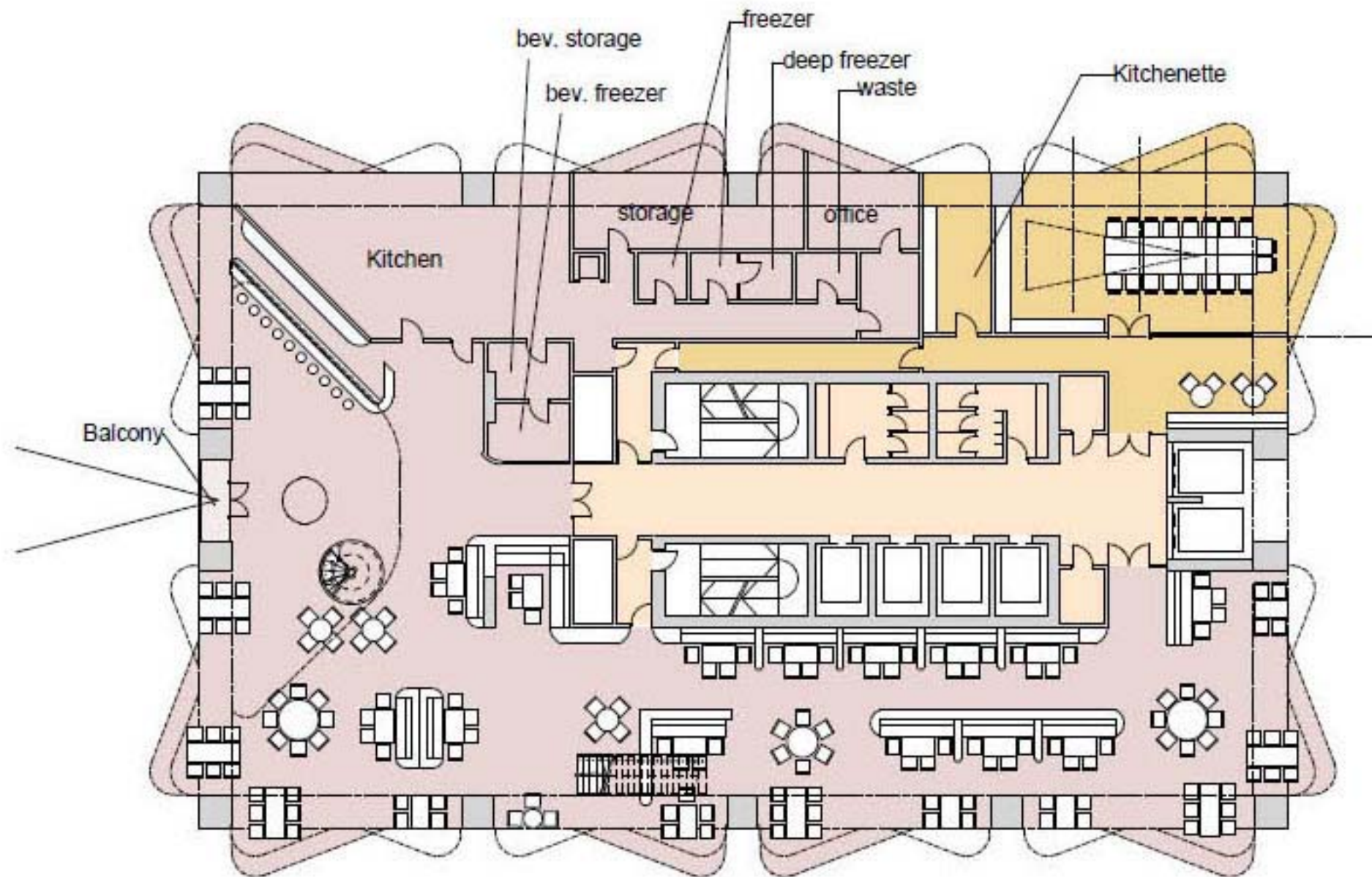

Gross Area: 1340 sqm

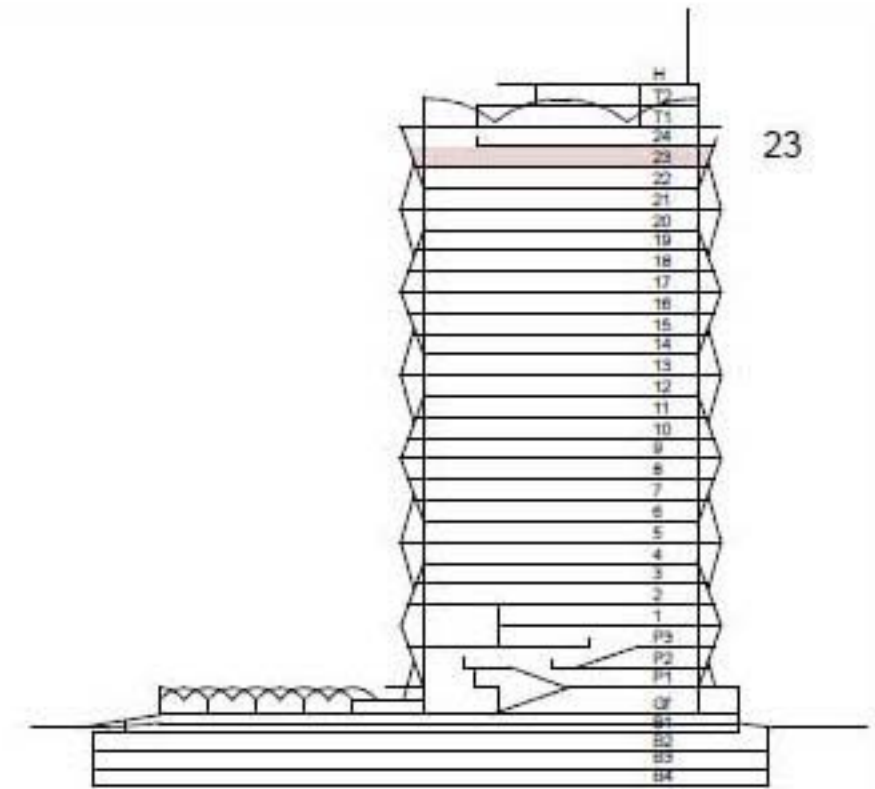
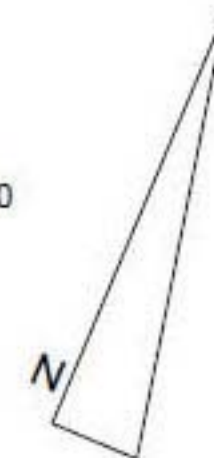
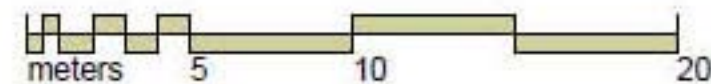

23rd Floor (Office)
- story 27

- Sky Restaurant *** - 890 sqm
- Floor Common Area (Lift Lobby) - 140 sqm
- VIP Meeting Room - 175 sqm
- Technical
- Building structure
- Vertical Circulation (Stairs/Elevators)
- Toilets

*** Instead of sky restaurant the upper two floors could be an office for a VIP tenant.

Marina Office Building

Office Building Concept Design
Location: Marina District, Doha, Qatar,
Plot: Marina Com 017
Date: Nov. 2013

Author:
Arch. Marius-Traian Danciu
Ecopolis Architecture Group-Bucharest

mariusdanciu.ecopolis@yahoo.com
marius.danciu@ecopolis.ro
tel: +40726 260424
www.ecopolis.ro
www.contactstudio.ro
www.proatrium.ro

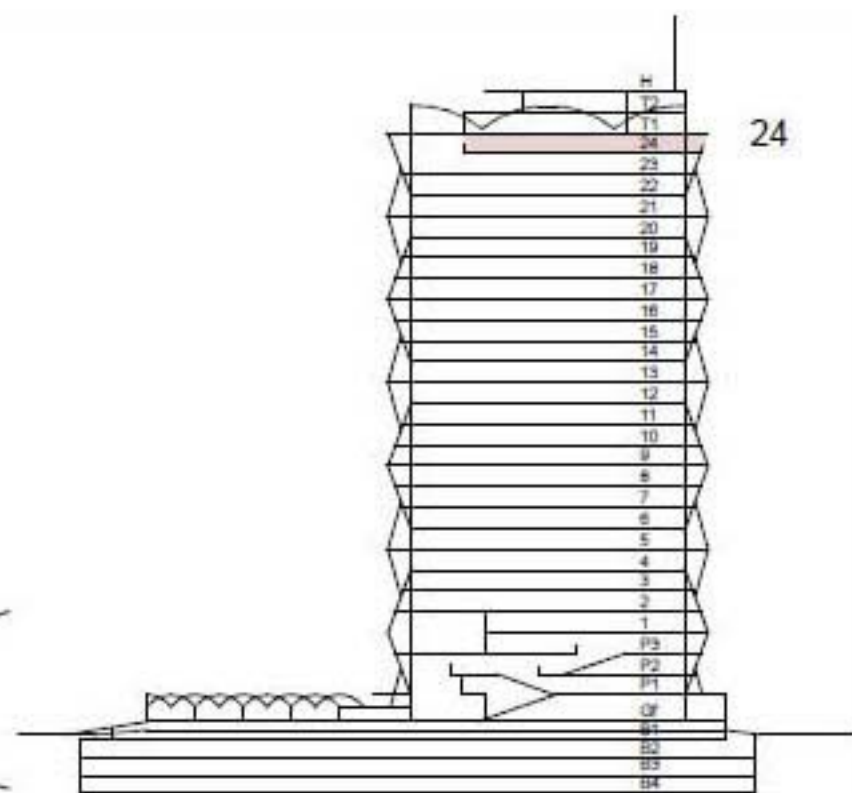
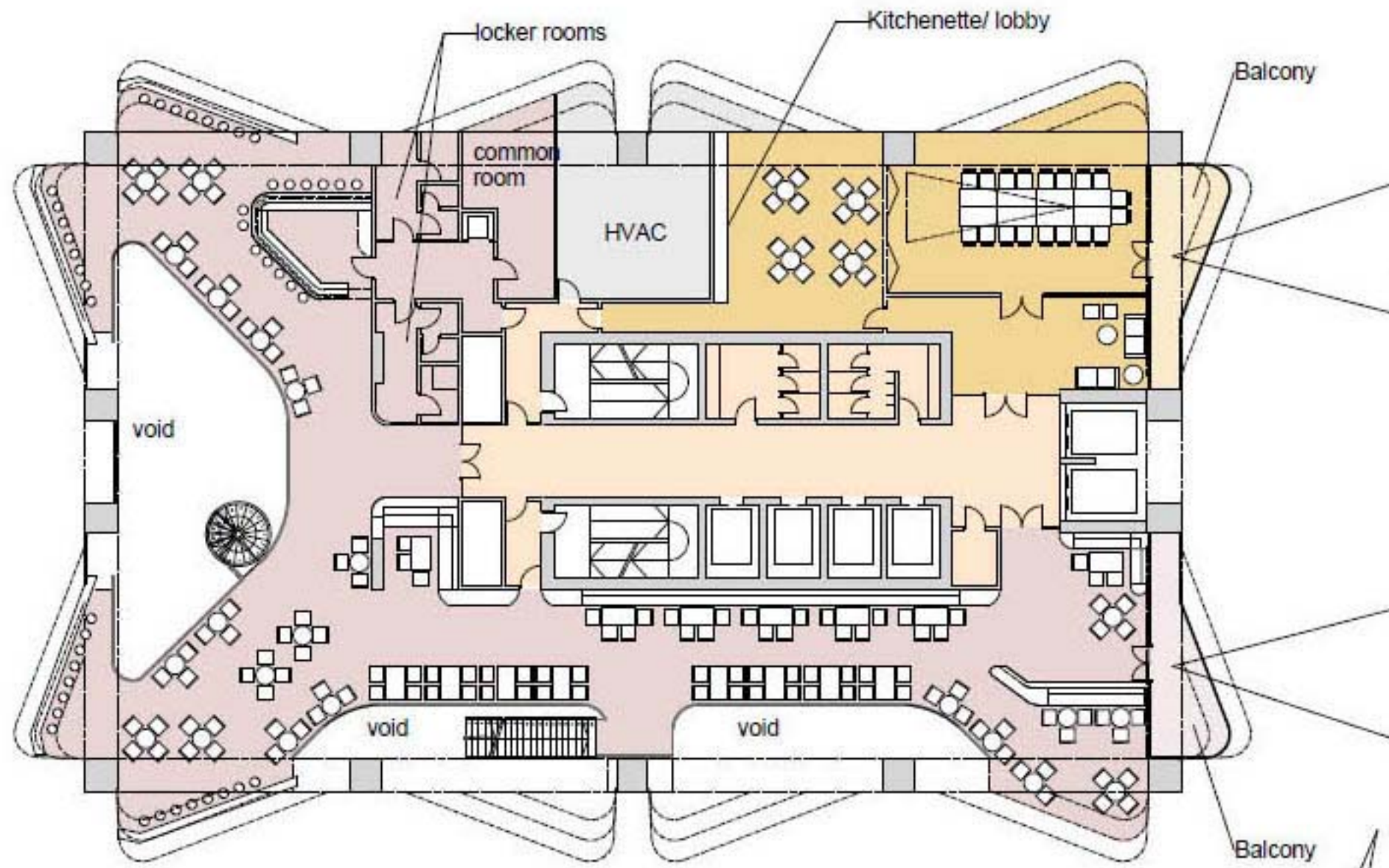

**24th Floor (Office)
- story 28**

- Sky Bar *** - 520 sqm (+balcony 20 sqm)
- Floor Common Area (Lift Lobby) - 140 sqm
- VIP Meeting Room - 185 sqm (+ balcony 20 sqm)
- Technical 50 sqm
- Building structure
- Vertical Circulation (Stairs/Elevators)
- Toilets

*** Instead of sky restaurant the upper two floors could be an office for a VIP tenant.

Gross Area: 1162 sqm





This project is the property of the Author and may not be used without his permission.

Marina Office Building
 Office Building Concept Design
 Location: Marina District, Doha, Qatar,
 Plot: Marina Com 017
 Date: Nov. 2013
 Author:
 Arch. Marius-Traian Danciu
 Ecopolis Architecture Group-Bucharest
 mariusdanciu.ecopolis@yahoo.com
 marius.danciu@ecopolis.ro
 tel: +40726 260424
 www.ecopolis.ro
 www.contactstudio.ro
 www.proatrium.ro

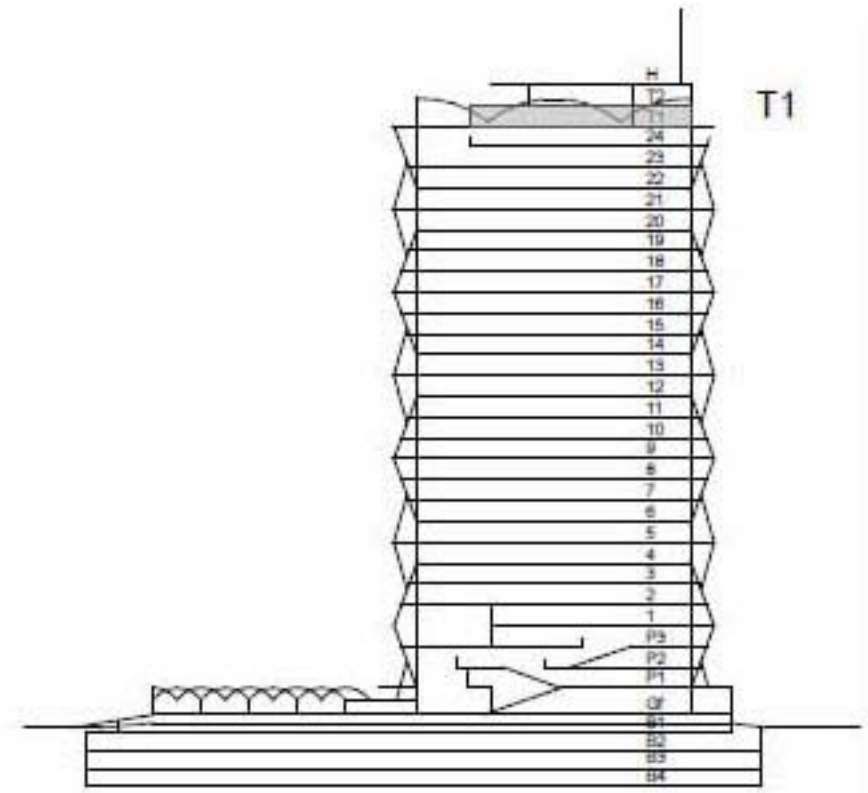
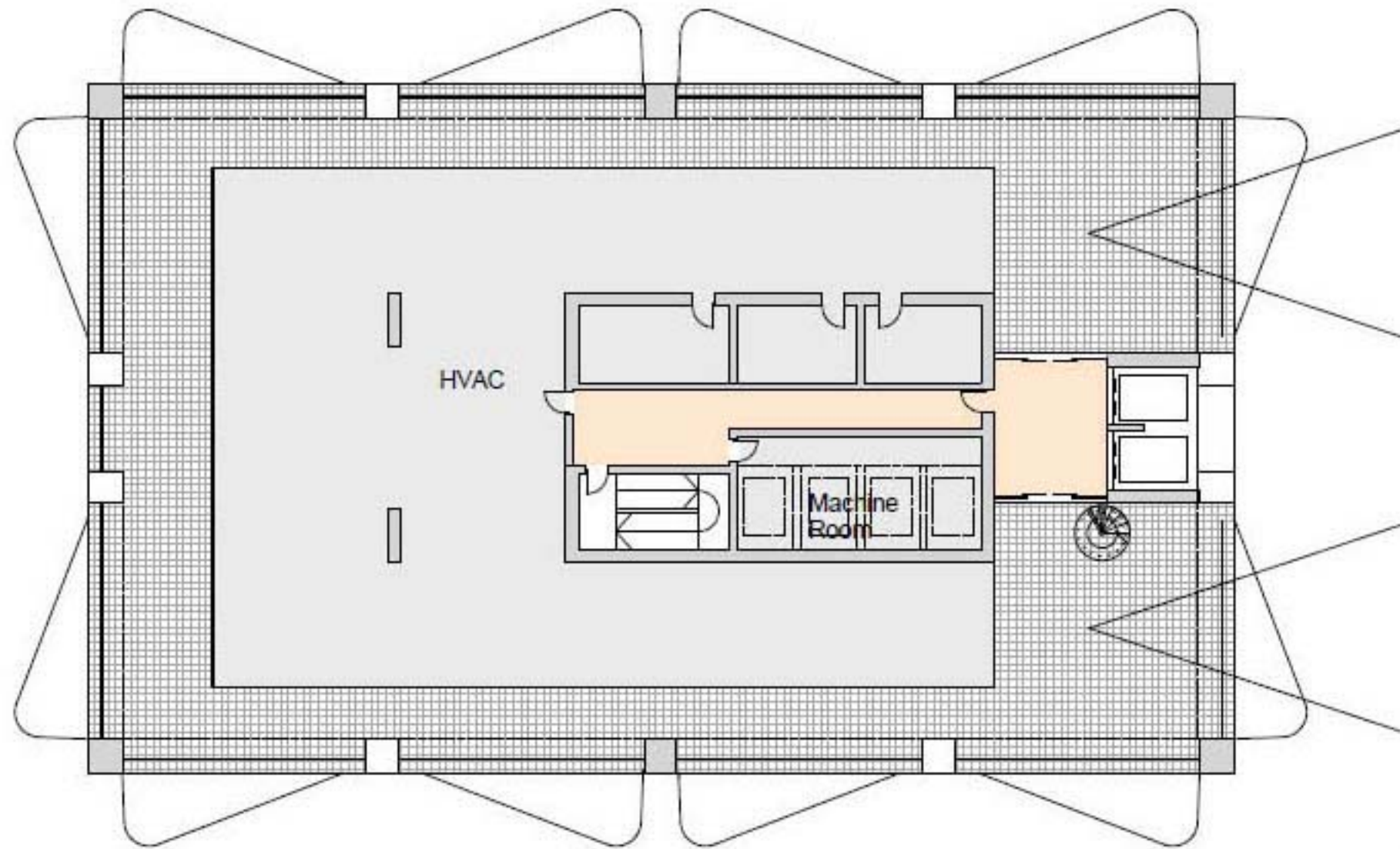
www.ecopolis.ro
 www.contactstudio.ro



Technical Floor 1

-  Floor Common Area 60 sqm
-  Roof Terrace
-  Technical - 585 qm
-  Building structure
-  Vertical Circulation (Stairs/Elevators)

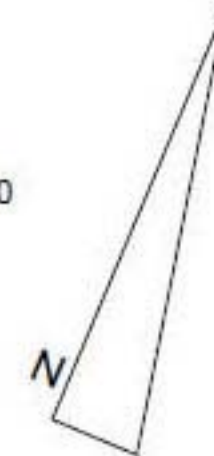
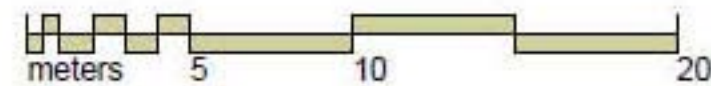

Gross Area: 685 sqm

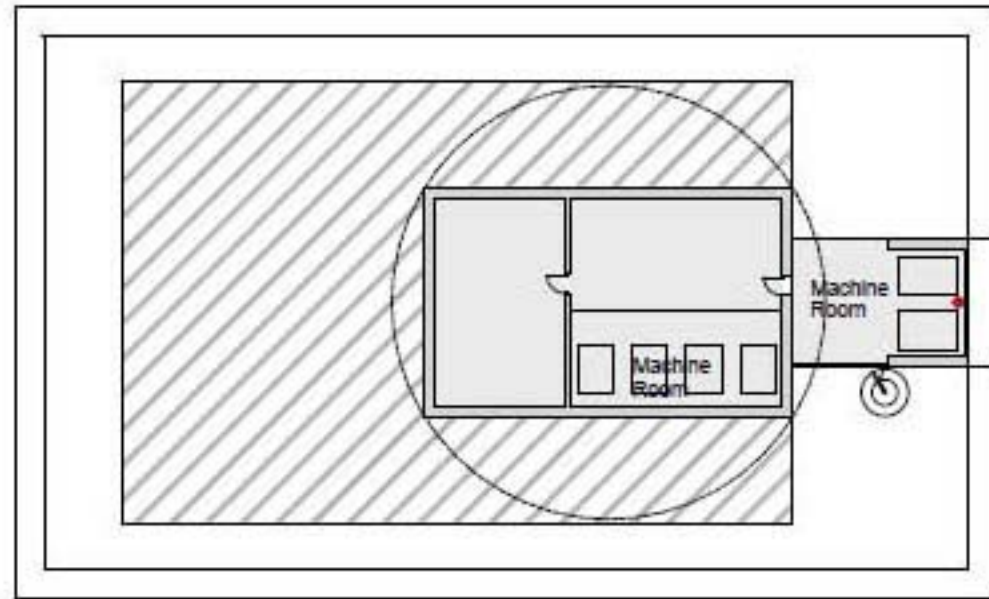

Gross Area: 230 sqm

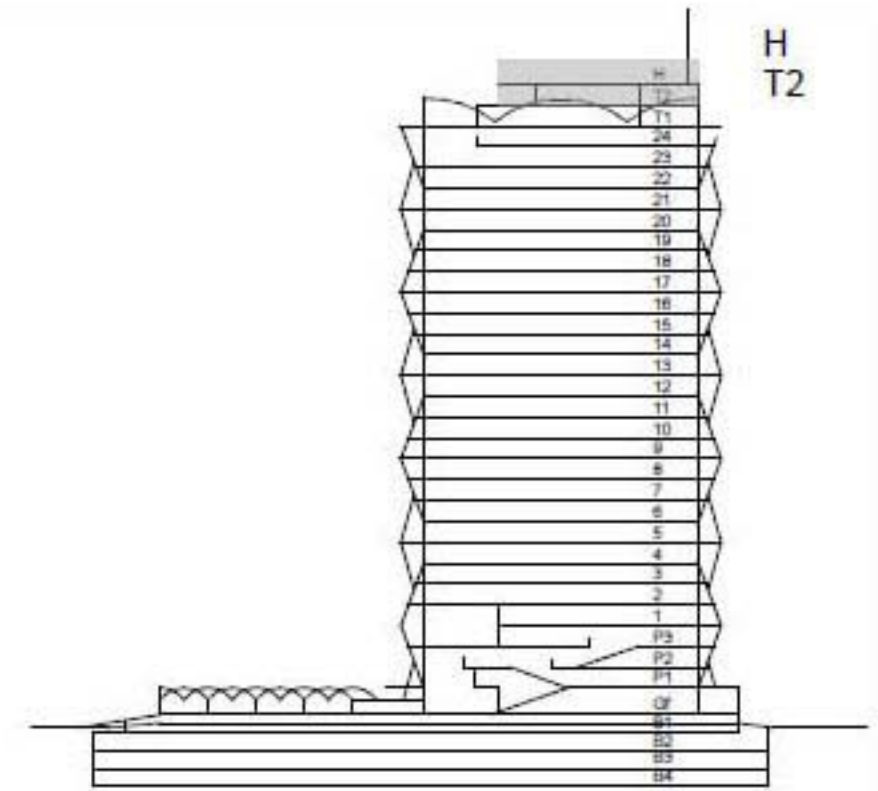
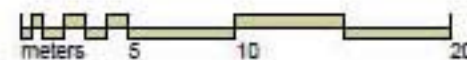
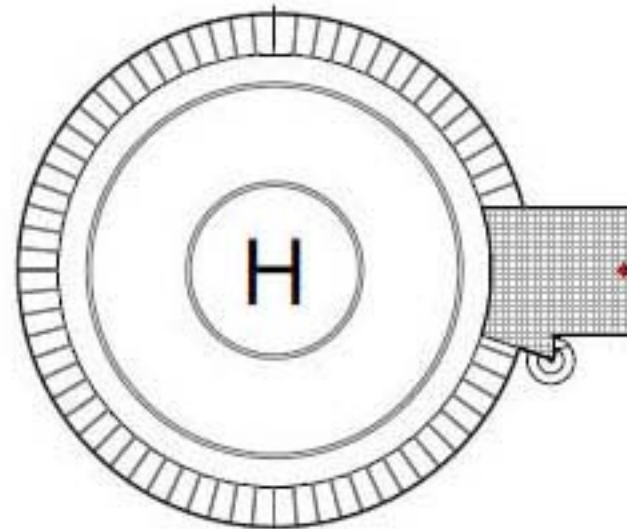
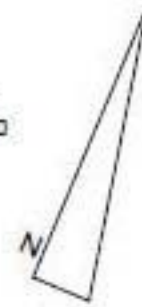
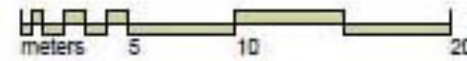

Technical Floor 2 Heliport on top

-  Technical
-  Building structure
-  Technical roof
-  Vertical Circulation (Stair)

Marina Office Building
 Office Building Concept Design
 Location: Marina District, Doha, Qatar,
 Plot: Marina Com 017
 Date: Nov. 2013

Author:
 Arch. Marius-Traian Danciu
 Ecopolis Architecture Group-Bucharest

mariusdanciu.ecopolis@yahoo.com
 marius.danciu@ecopolis.ro
 tel: +40726 260424
 www.ecopolis.ro
 www.contactstudio.ro
 www.proatrium.ro

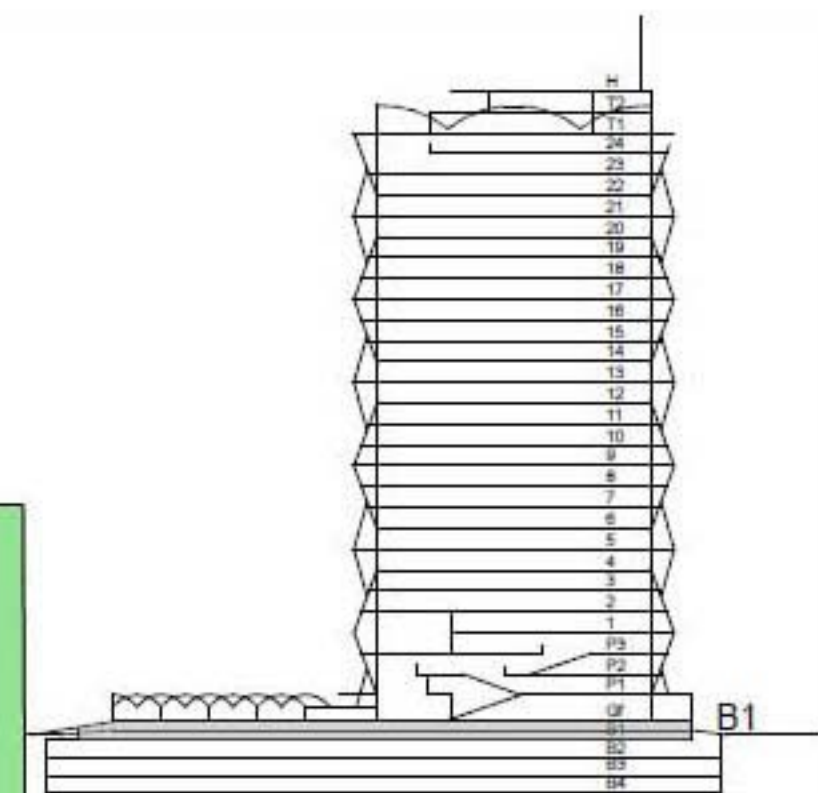
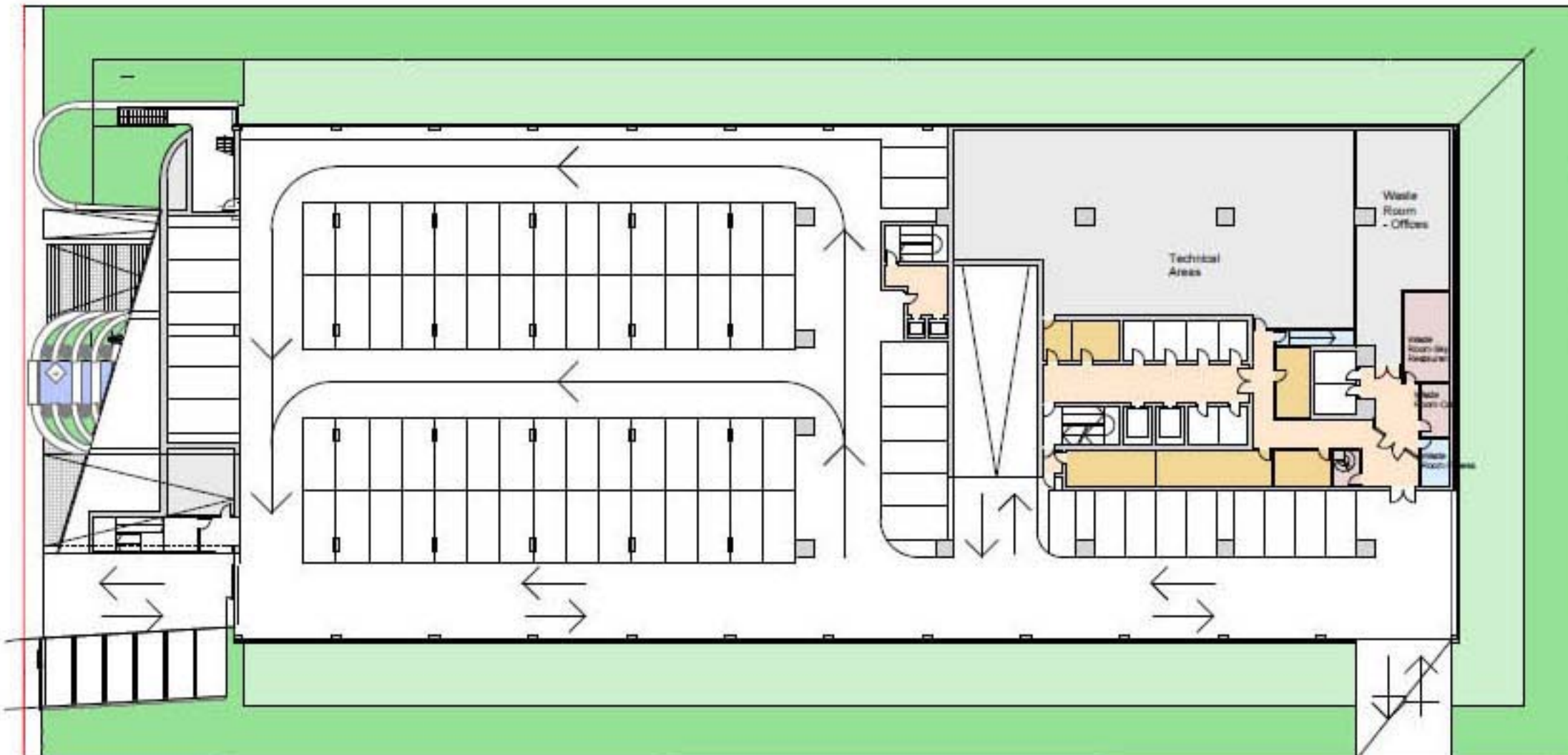

**1st Basement Floor -1.5m
- story -1**

- Car Parking places 83 underground
- Storage for tenants - 95 sqm
- Technical area and shafts - 560 sqm
- Building structure
- Common Area - 137.5 sqm
- Vertical Circulation (Stairs/Elevators)
- Sky Restaurant & Bar/ Cafe Bar - 40 sqm
- Commercial Area (Fitness & Spa) - 10 sqm
- Green Area with/without Basement

Gross Area: 4200 sqm

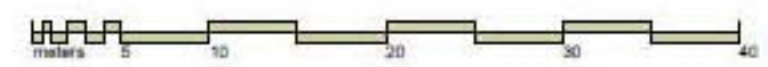

Marina Office Building
 Office Building Concept Design
 Location: Marina District, Doha, Qatar,
 Plot: Marina Com 017
 Date: Nov. 2013





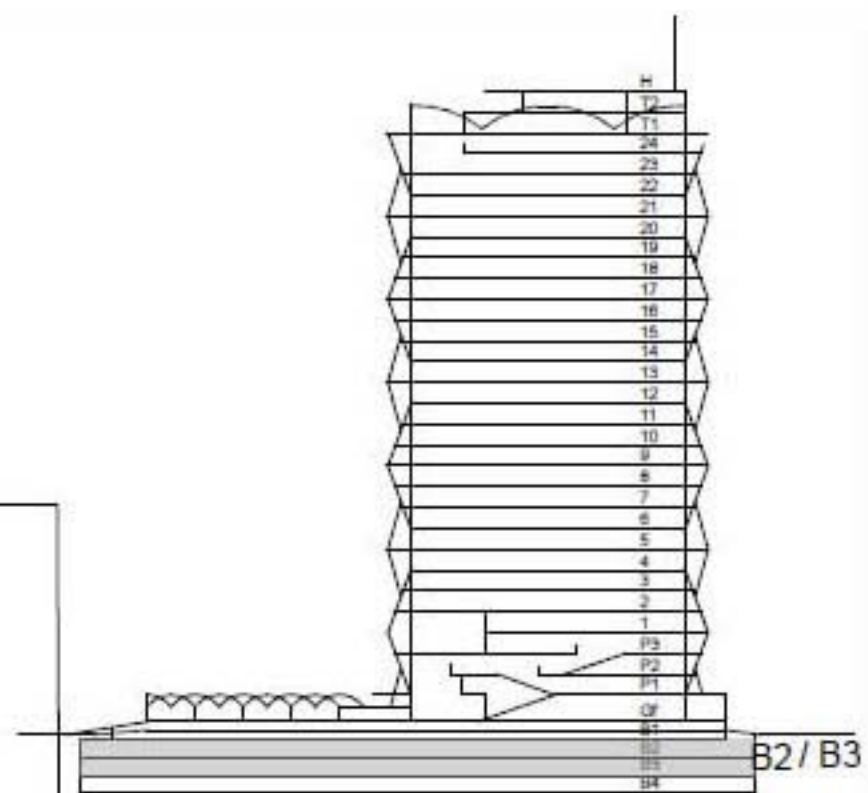
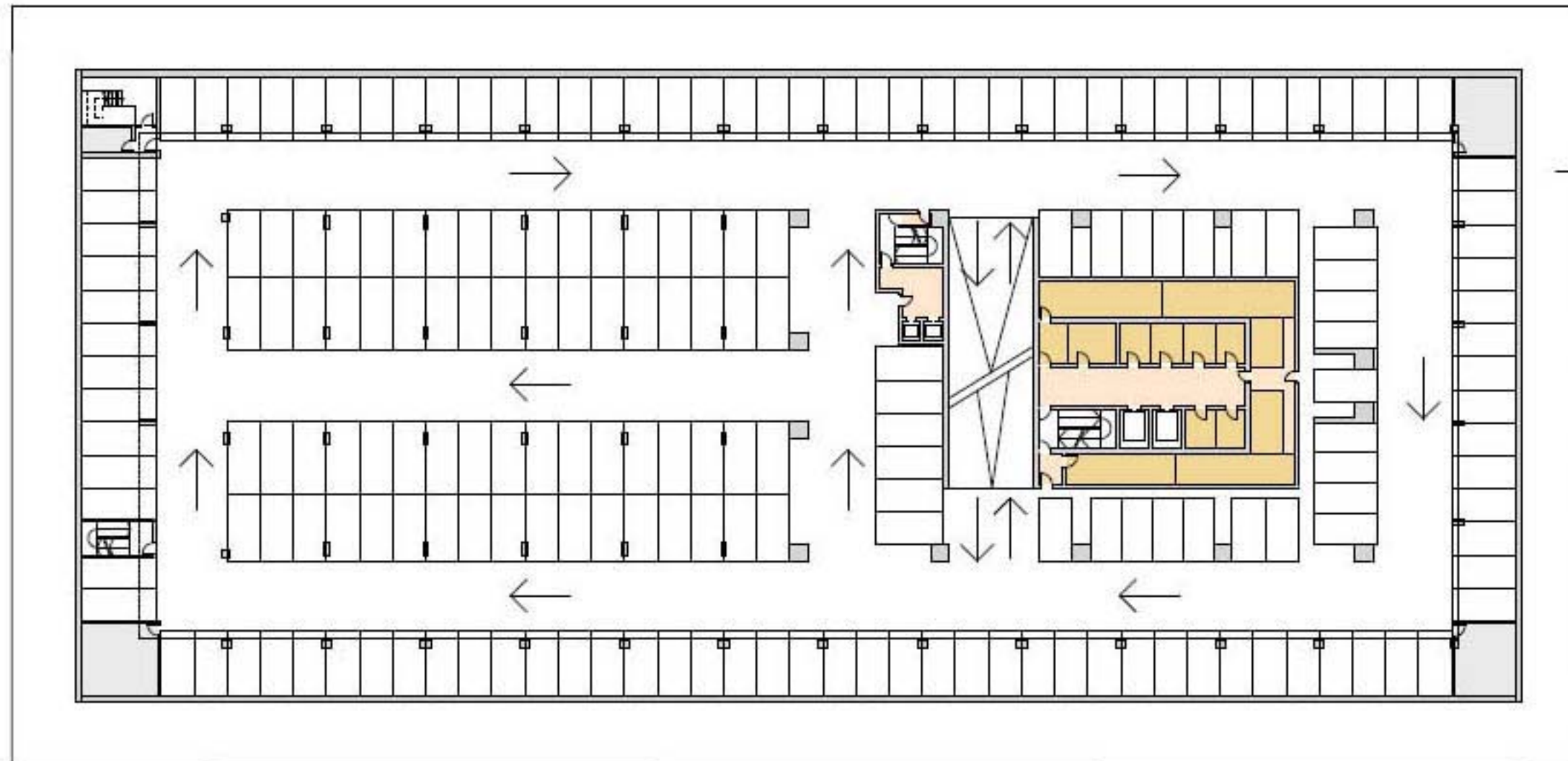

Author:
 Arch. Marius-Traian Danciu
 Ecopolis Architecture Group-Bucharest

mariusdanciu.ecopolis@yahoo.com
 marius.danciu@ecopolis.ro
 tel: +40726 260424
 www.ecopolis.ro
 www.contactstudio.ro
 www.proatrium.ro





**2nd/3rd Basement Floor
- stories -2/-3**

-  Car Parking places 203
-  Storage for tenants - 185 sqm
-  Technical area and shafts - 100 sqm
-  Building structure
-  Common Area - 80 sqm
-  Vertical Circulation (Stairs/Elevators)

Gross Area: 5640 sqm

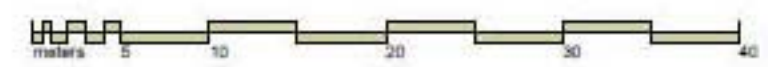

Marina Office Building
 Office Building Concept Design
 Location: Marina District, Doha, Qatar,
 Plot: Marina Com 017
 Date: Nov. 2013





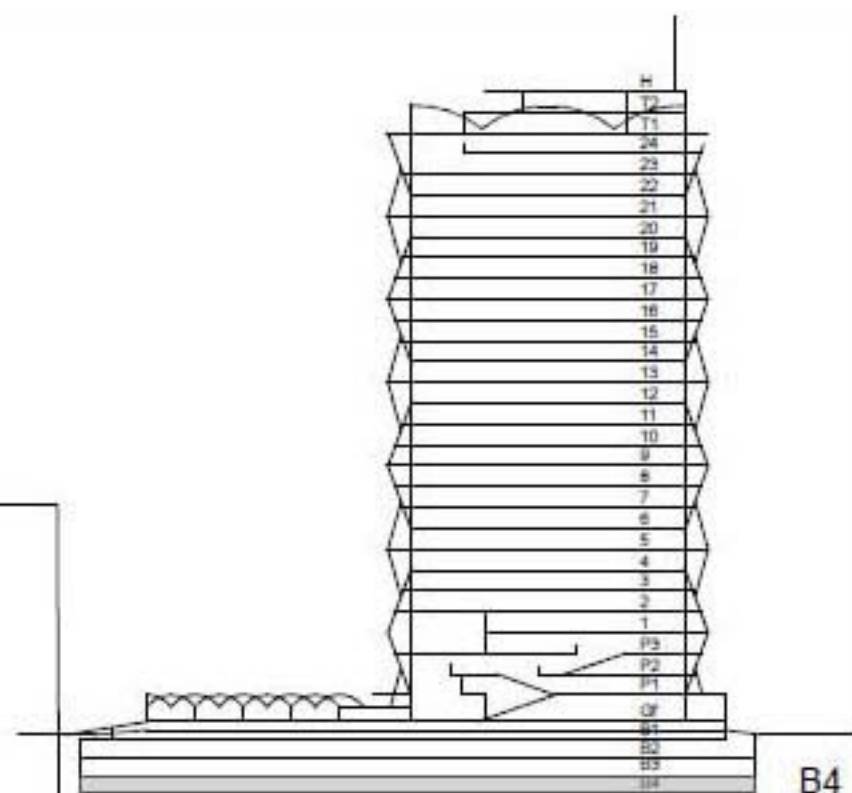
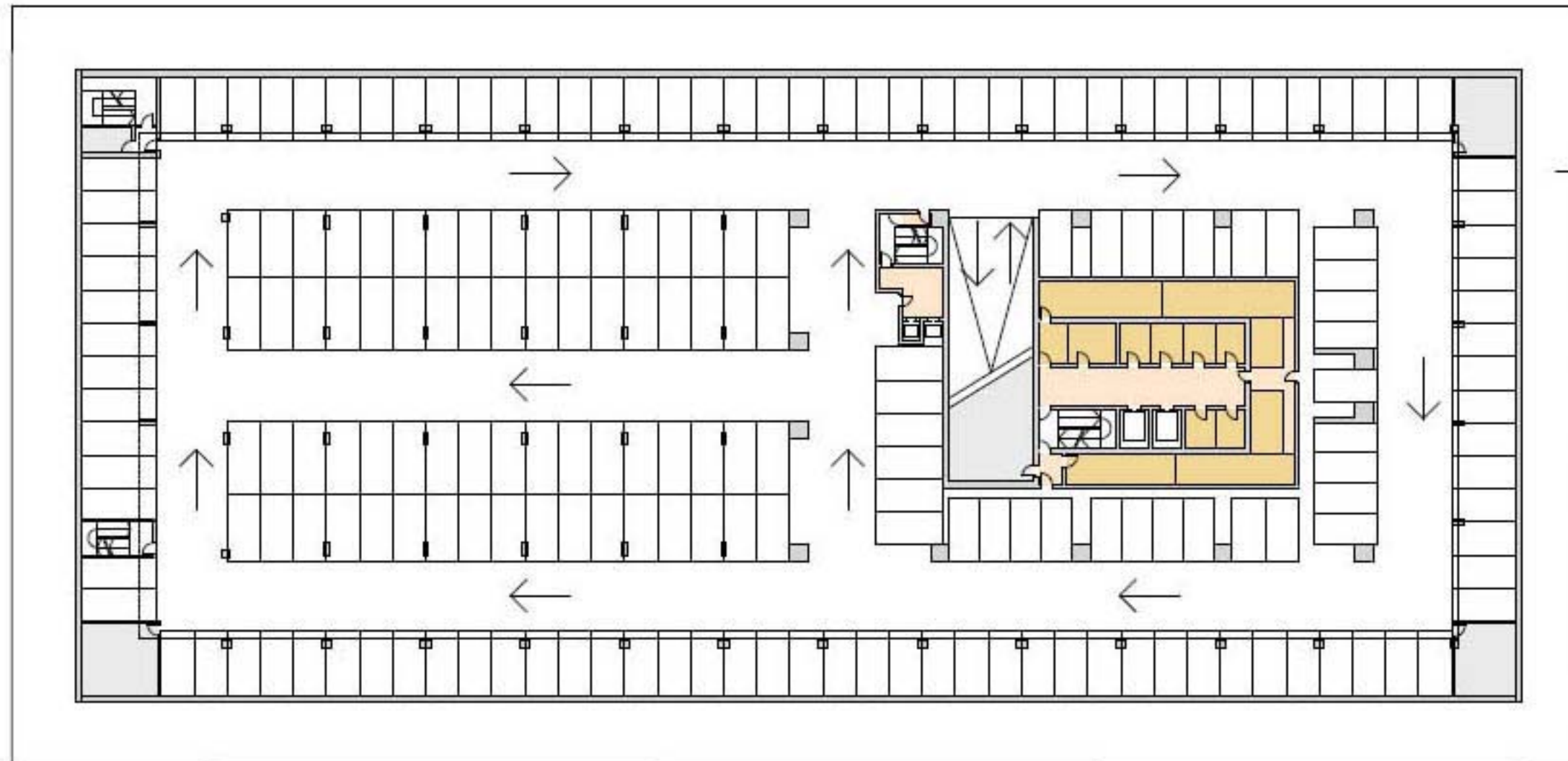

Author:
 Arch. Marius-Traian Danciu
 Ecopolis Architecture Group-Bucharest

mariusdanciu.ecopolis@yahoo.com
 marius.danciu@ecopolis.ro
 tel: +40726 260424
 www.ecopolis.ro
 www.contactstudio.ro
 www.proatrium.ro





**4th Basement Floor
- story - 4**

-  Car Parking places 203
-  Storage for tenants - 185 sqm
-  Technical area and shafts - 150 sqm
-  Building structure
-  Common Area - 80 sqm
-  Vertical Circulation (Stairs/Elevators)

Gross Area: 5640 sqm

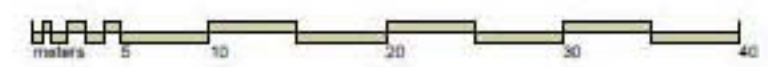

Marina Office Building
 Office Building Concept Design
 Location: Marina District, Doha, Qatar,
 Plot: Marina Com 017
 Date: Nov. 2013

Author:
 Arch. Marius-Traian Danciu
 Ecopolis Architecture Group-Bucharest

mariusdanciu.ecopolis@yahoo.com
 marius.danciu@ecopolis.ro
 tel: +40726 260424
 www.ecopolis.ro
 www.contactstudio.ro
 www.proatrium.ro



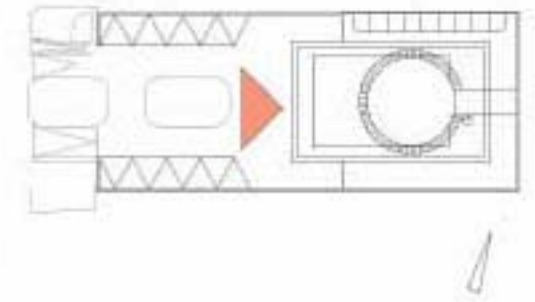

Exterior perspective 1

Author: arch. Marius Danciu - nov. 2013

Marina Office Building

Office Building Concept Design
Location: Marina District, Doha, Qatar,
Plot: Marina Com 017
Date: Nov. 2013

Author:
Arch. Marius-Traian Danciu
Ecopolis Architecture Group-Bucharest

mariusdanciu.ecopolis@yahoo.com
marius.danciu@ecopolis.ro
tel: +40726 260424
www.ecopolis.ro
www.contactstudio.ro
www.proatrium.ro



Ecopolis
Architecture
Group

This project is the property of the Author and may not be used without his permission.

www.ecopolis.ro
www.contactstudio.ro

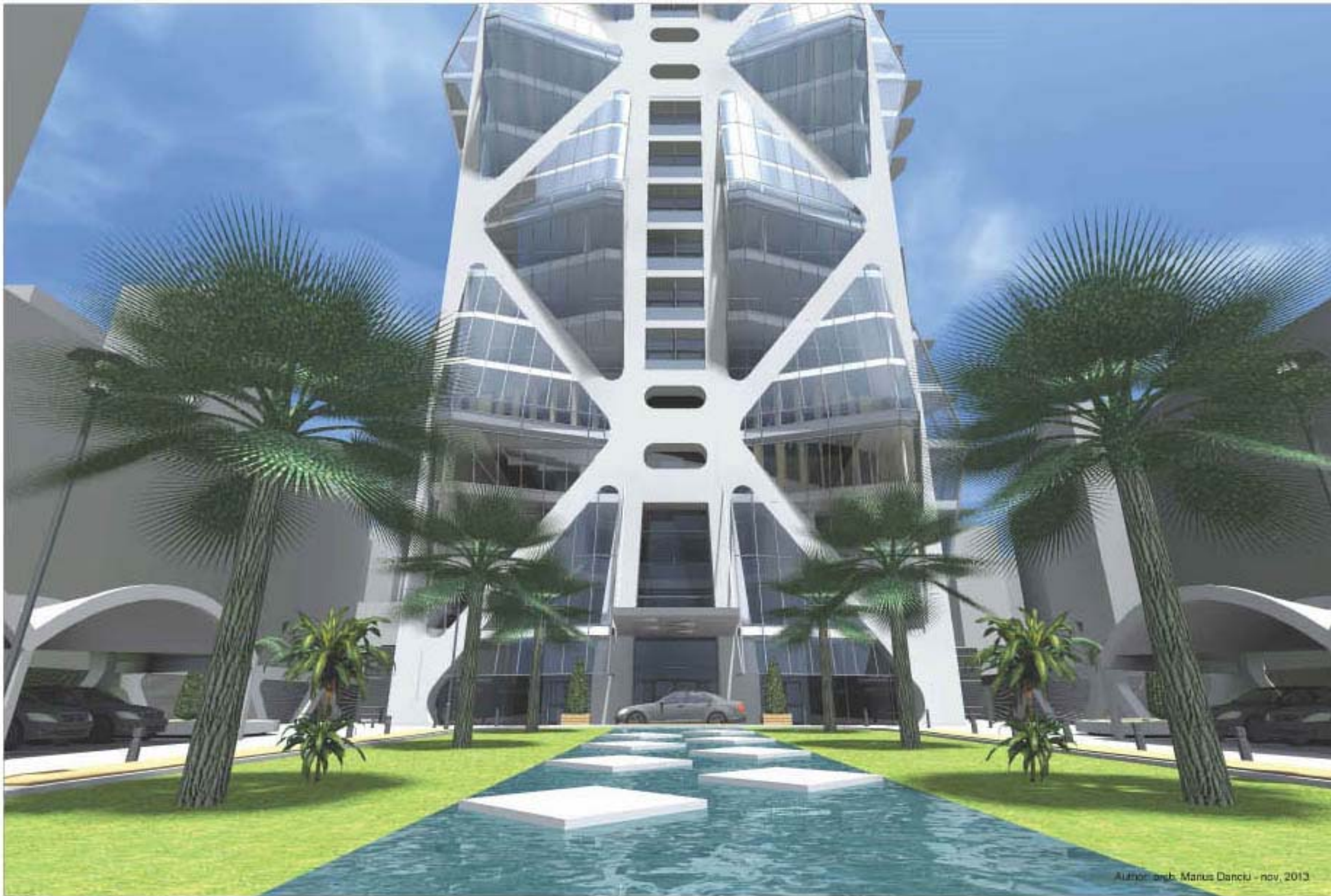

Author: arch. Marius Danciu - nov, 2013

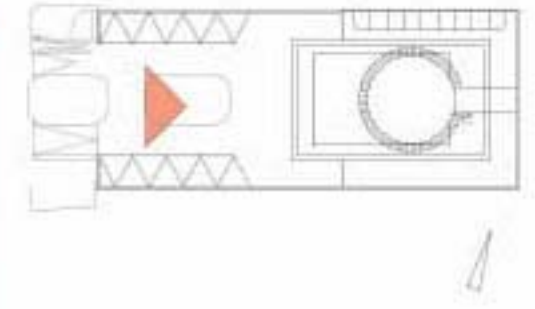

Exterior perspective 3

Marina Office Building
Office Building Concept Design
Location: Marina District, Doha, Qatar,
Plot: Marina Com 017
Date: Nov. 2013

Author:
Arch. Marius-Traian Danciu
Ecopolis Architecture Group-Bucharest

mariusdanciu.ecopolis@yahoo.com
marius.danciu@ecopolis.ro
tel: +40726 260424
www.ecopolis.ro
www.contactstudio.ro
www.proatrium.ro



This project is the property of the Author and may not be used without his permission.

www.ecopolis.ro
www.contactstudio.ro

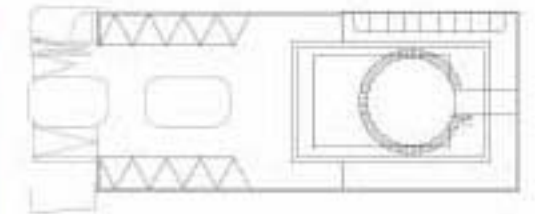
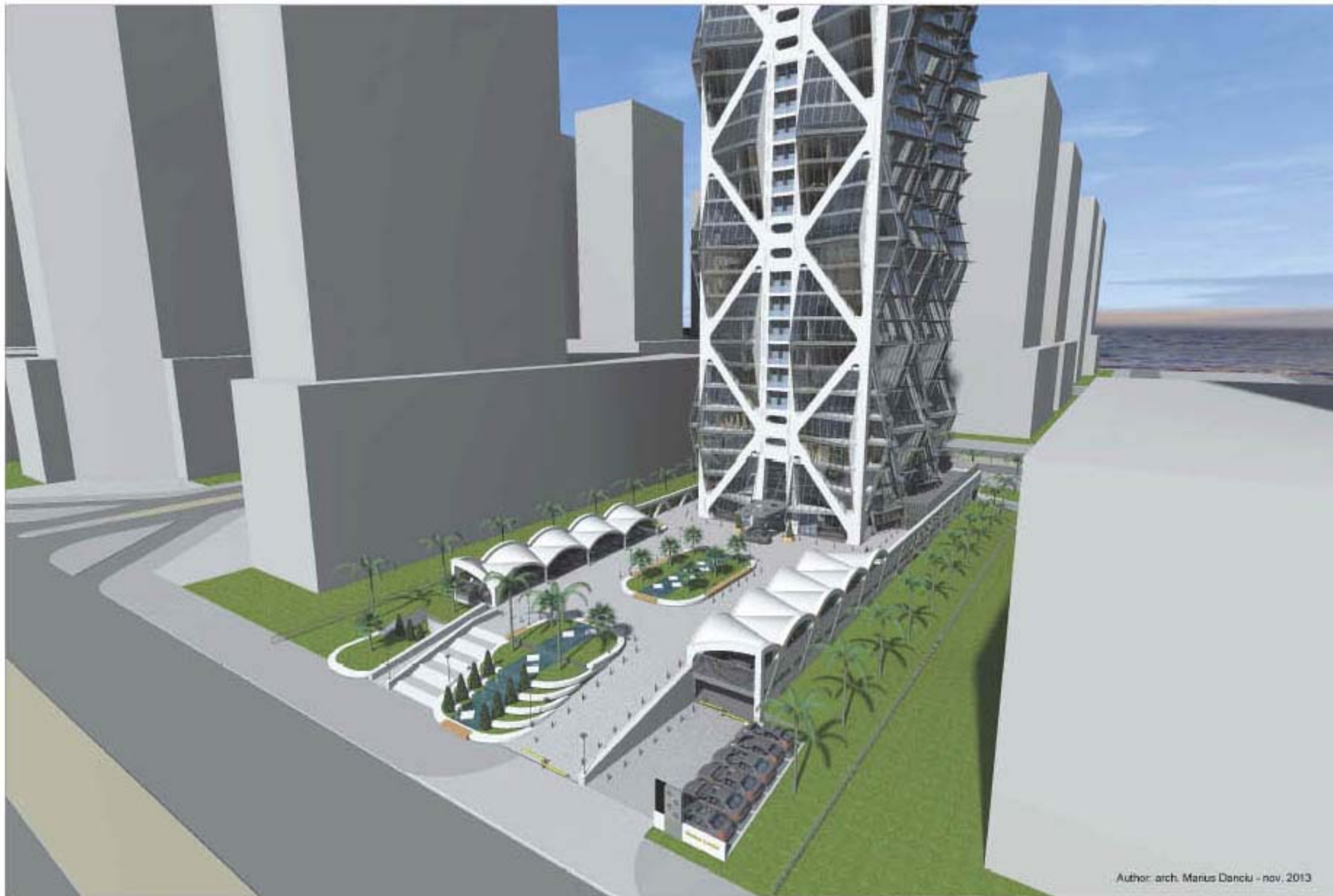

Exterior perspective 4

Author: arch. Marius Danciu - nov. 2013

Marina Office Building

Office Building Concept Design
Location: Marina District, Doha, Qatar,
Plot: Marina Com 017
Date: Nov. 2013

Author:
Arch. Marius-Traian Danciu
Ecopolis Architecture Group-Bucharest

mariusdanciu.ecopolis@yahoo.com
marius.danciu@ecopolis.ro
tel: +40726 260424
www.ecopolis.ro
www.contactstudio.ro
www.proatrium.ro



Ecopolis
Architecture
Group

This project is the property of the Author and may not be used without his permission.

www.ecopolis.ro
www.contactstudio.ro

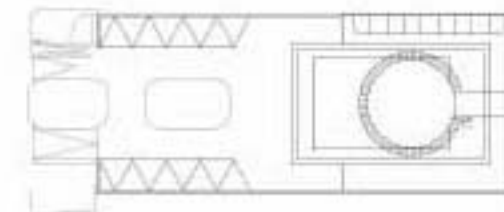

Exterior perspective 5

Marina Office Building

Office Building Concept Design
Location: Marina District, Doha, Qatar,
Plot: Marina Com 017
Date: Nov. 2013

Author:
Arch. Marius-Traian Danciu
Ecopolis Architecture Group-Bucharest

mariusdanciu.ecopolis@yahoo.com
marius.danciu@ecopolis.ro
tel: +40726 260424
www.ecopolis.ro
www.contactstudio.ro
www.proatrium.ro



Ecopolis
Architecture
Group

This project is the property of the Author and may not be used without his permission.

www.ecopolis.ro
www.contactstudio.ro

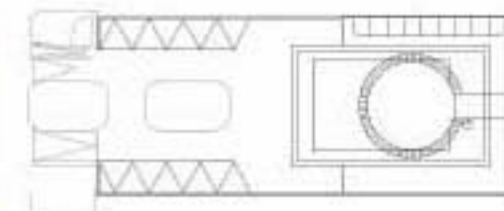
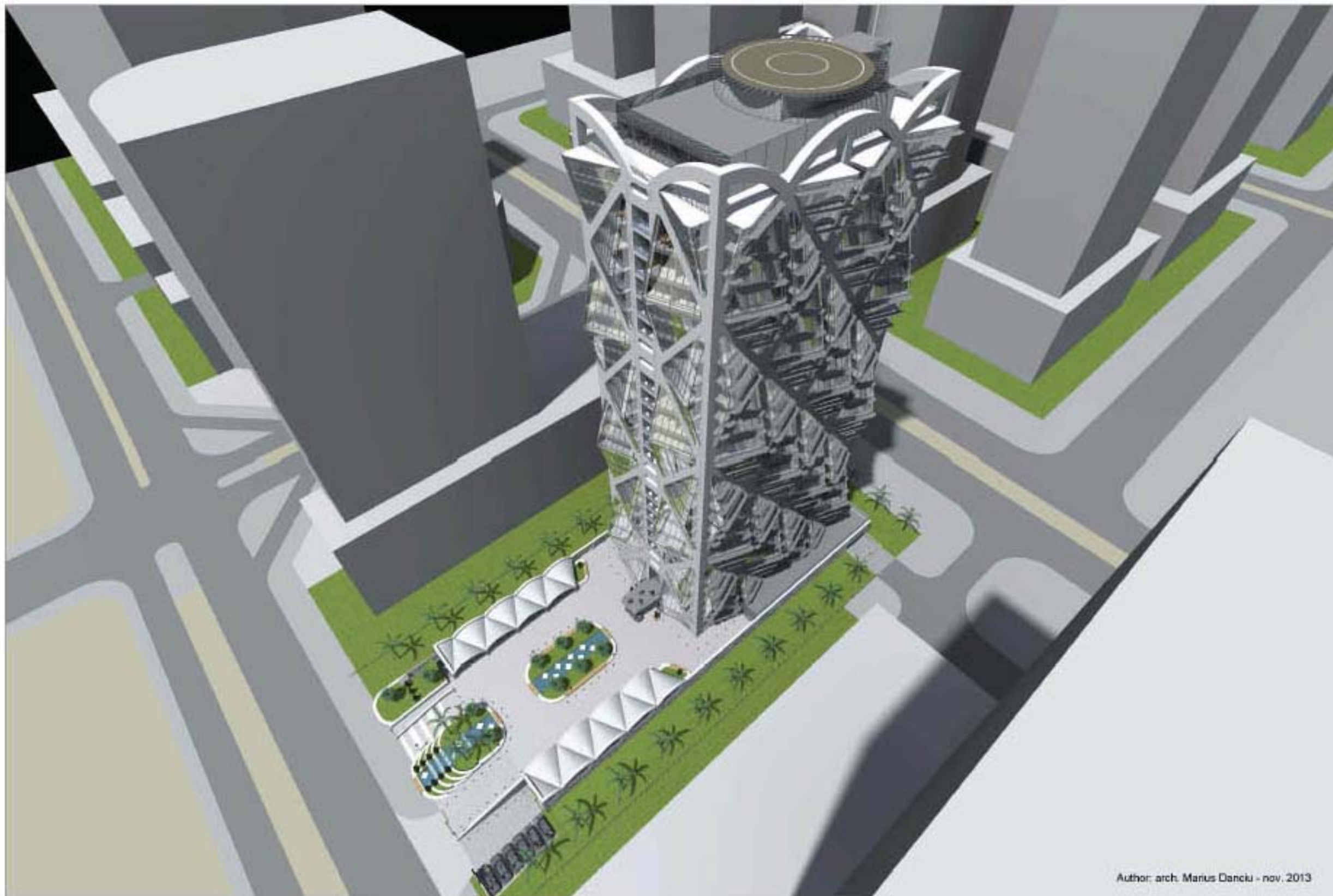

Exterior perspective 6

Author: arch. Marius Danciu - nov. 2013

Marina Office Building

Office Building Concept Design
Location: Marina District, Doha, Qatar,
Plot: Marina Com 017
Date: Nov. 2013

Author:
Arch. Marius-Traian Danciu
Ecopolis Architecture Group-Bucharest

mariusdanciu.ecopolis@yahoo.com
marius.danciu@ecopolis.ro
tel: +40726 260424
www.ecopolis.ro
www.contactstudio.ro
www.proatrium.ro



Ecopolis
Architecture
Group

This project is the property of the Author and may not be used without his permission.

www.ecopolis.ro
www.contactstudio.ro

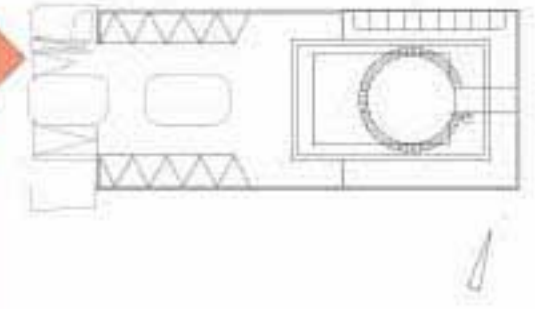

Exterior perspective 8

Author: arch. Marius Danciu - nov. 2013

Marina Office Building
Office Building Concept Design
Location: Marina District, Doha, Qatar,
Plot: Marina Com 017
Date: Nov. 2013

Author:
Arch. Marius-Traian Danciu
Ecopolis Architecture Group-Bucharest

mariusdanciu.ecopolis@yahoo.com
marius.danciu@ecopolis.ro
tel: +40726 260424
www.ecopolis.ro
www.contactstudio.ro
www.proatrium.ro



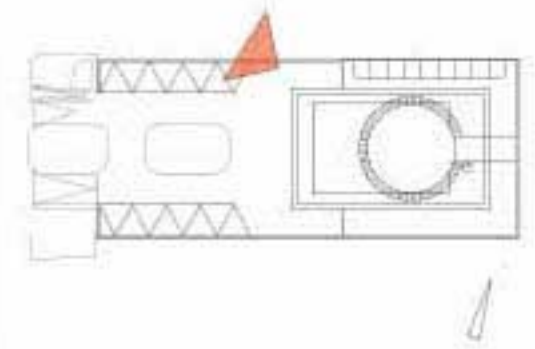

Exterior perspective 9

Author: arch. Marius Danciu - nov. 2013

Marina Office Building

Office Building Concept Design
Location: Marina District, Doha, Qatar,
Plot: Marina Com 017
Date: Nov. 2013

Author:
Arch. Marius-Traian Danciu
Ecopolis Architecture Group-Bucharest

mariusdanciu.ecopolis@yahoo.com
marius.danciu@ecopolis.ro
tel: +40726 260424
www.ecopolis.ro
www.contactstudio.ro
www.proatrium.ro



Ecopolis
Architecture
Group

This project is the property of the Author and may not be used without his permission.

www.ecopolis.ro
www.contactstudio.ro

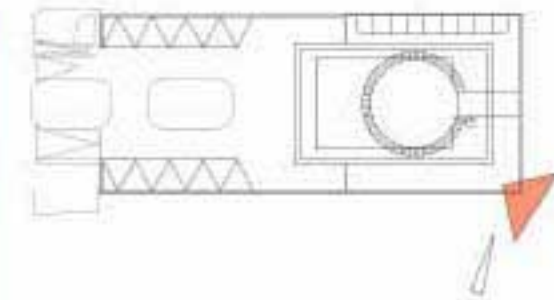
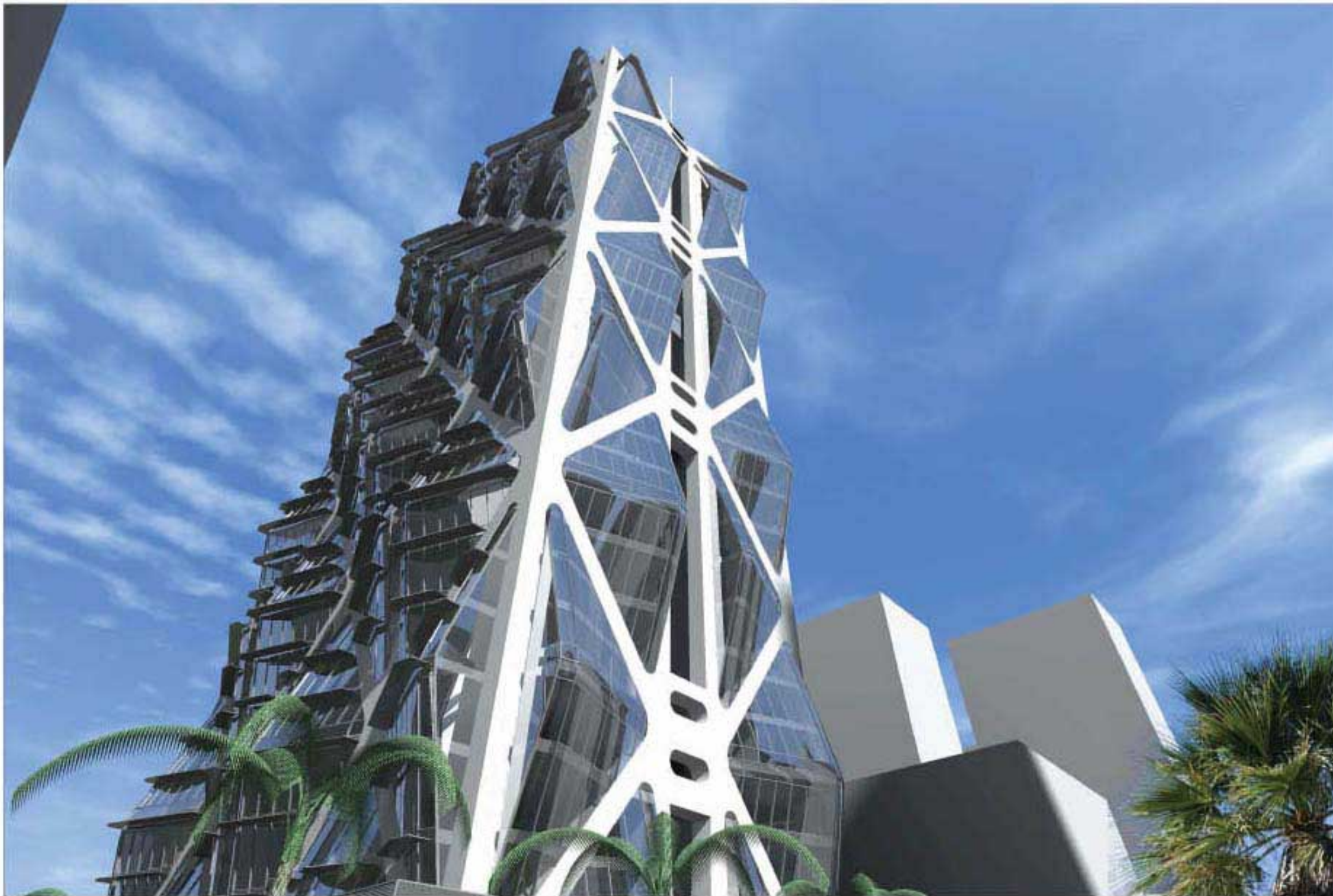

Exterior perspective 10

Marina Office Building

Office Building Concept Design
Location: Marina District, Doha, Qatar,
Plot: Marina Com 017
Date: Nov. 2013

Author:
Arch. Marius-Traian Danciu
Ecopolis Architecture Group-Bucharest

mariusdanciu.ecopolis@yahoo.com
marius.danciu@ecopolis.ro
tel: +40726 260424
www.ecopolis.ro
www.contactstudio.ro
www.proatrium.ro



Ecopolis
Architecture
Group

This project is the property of the Author and may not be used without his permission.

www.ecopolis.ro
www.contactstudio.ro

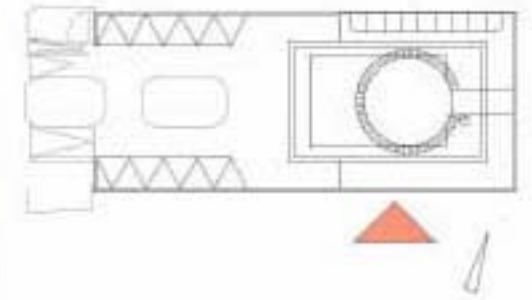

Exterior perspective 12

Marina Office Building

Office Building Concept Design
Location: Marina District, Doha, Qatar,
Plot: Marina Com 017
Date: Nov. 2013

Author:
Arch. Marius-Traian Danciu
Ecopolis Architecture Group-Bucharest

mariusdanciu.ecopolis@yahoo.com
marius.danciu@ecopolis.ro
tel: +40726 260424
www.ecopolis.ro
www.contactstudio.ro
www.proatrium.ro



Ecopolis
Architecture
Group

This project is the property of the Author and may not be used without his permission.

www.ecopolis.ro
www.contactstudio.ro

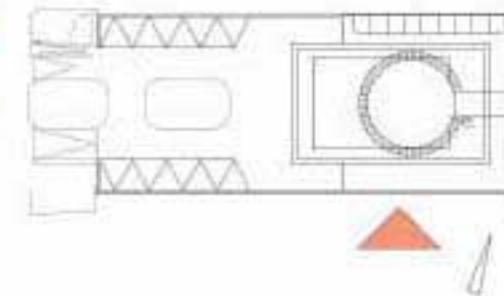
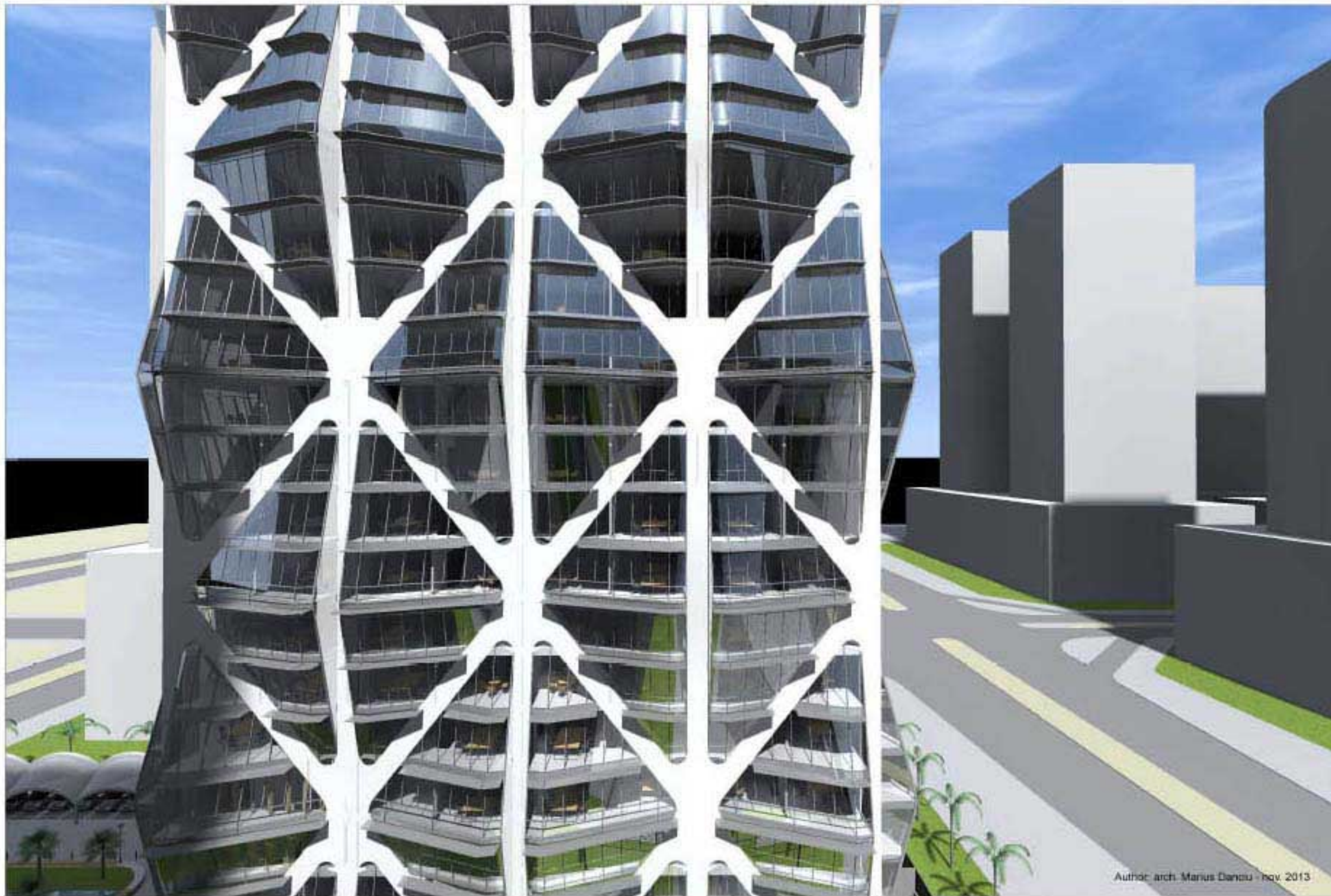

Exterior perspective 13

Author: arch. Marius Danciu - hqv, 2013

Marina Office Building

Office Building Concept Design
Location: Marina District, Doha, Qatar,
Plot: Marina Com 017
Date: Nov. 2013

Author:
Arch. Marius-Traian Danciu
Ecopolis Architecture Group-Bucharest

mariusdanciu.ecopolis@yahoo.com
marius.danciu@ecopolis.ro
tel: +40726 260424
www.ecopolis.ro
www.contactstudio.ro
www.proatrium.ro



Ecopolis
Architecture
Group

This project is the property of the Author and may not be used without his permission.

www.ecopolis.ro
www.contactstudio.ro



Author: arch. Marius Danciu - nov. 2013

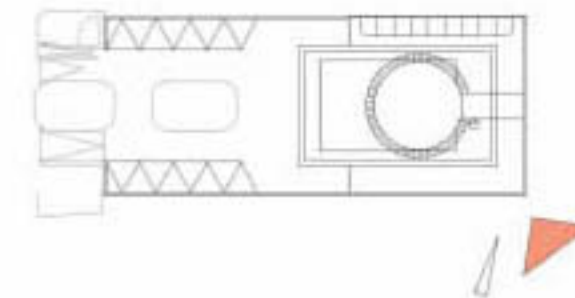

Exterior perspective 14

Marina Office Building

Office Building Concept Design
Location: Marina District, Doha, Qatar,
Plot: Marina Com 017
Date: Nov. 2013

Author:
Arch. Marius-Traian Danciu
Ecopolis Architecture Group-Bucharest

mariusdanciu.ecopolis@yahoo.com
marius.danciu@ecopolis.ro
tel: +40726 260424
www.ecopolis.ro
www.contactstudio.ro
www.proatrium.ro



Ecopolis
Architecture
Group

This project is the property of the Author and may not be used without his permission.

www.ecopolis.ro
www.contactstudio.ro

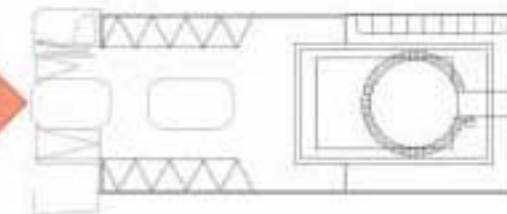
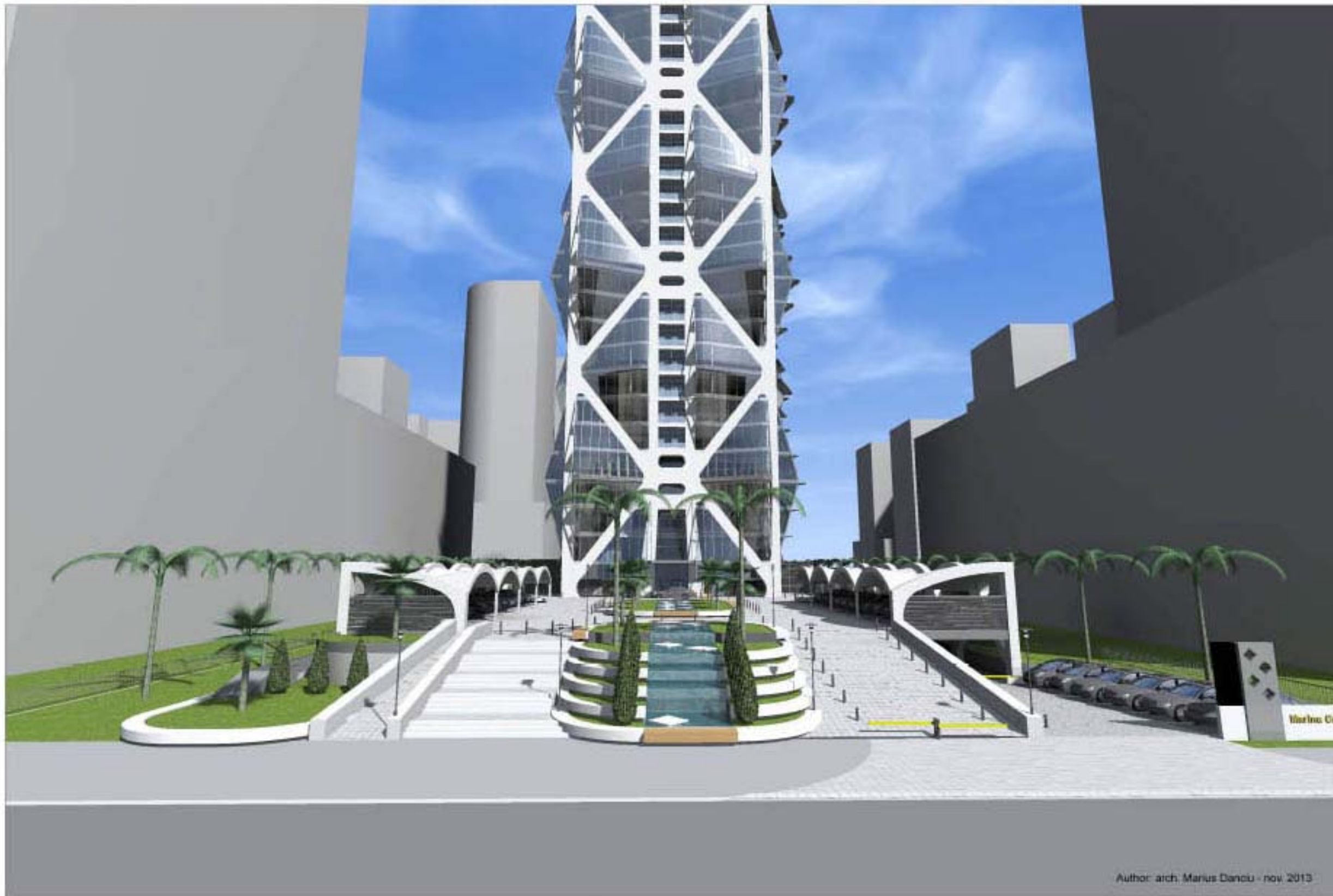

Exterior perspective 15

Author: arch. Marius Danciu - nov. 2013

Marina Office Building

Office Building Concept Design
Location: Marina District, Doha, Qatar,
Plot: Marina Com 017
Date: Nov. 2013

Author:
Arch. Marius-Traian Danciu
Ecopolis Architecture Group-Bucharest

mariusdanciu.ecopolis@yahoo.com
marius.danciu@ecopolis.ro
tel: +40726 260424
www.ecopolis.ro
www.contactstudio.ro
www.proatrium.ro

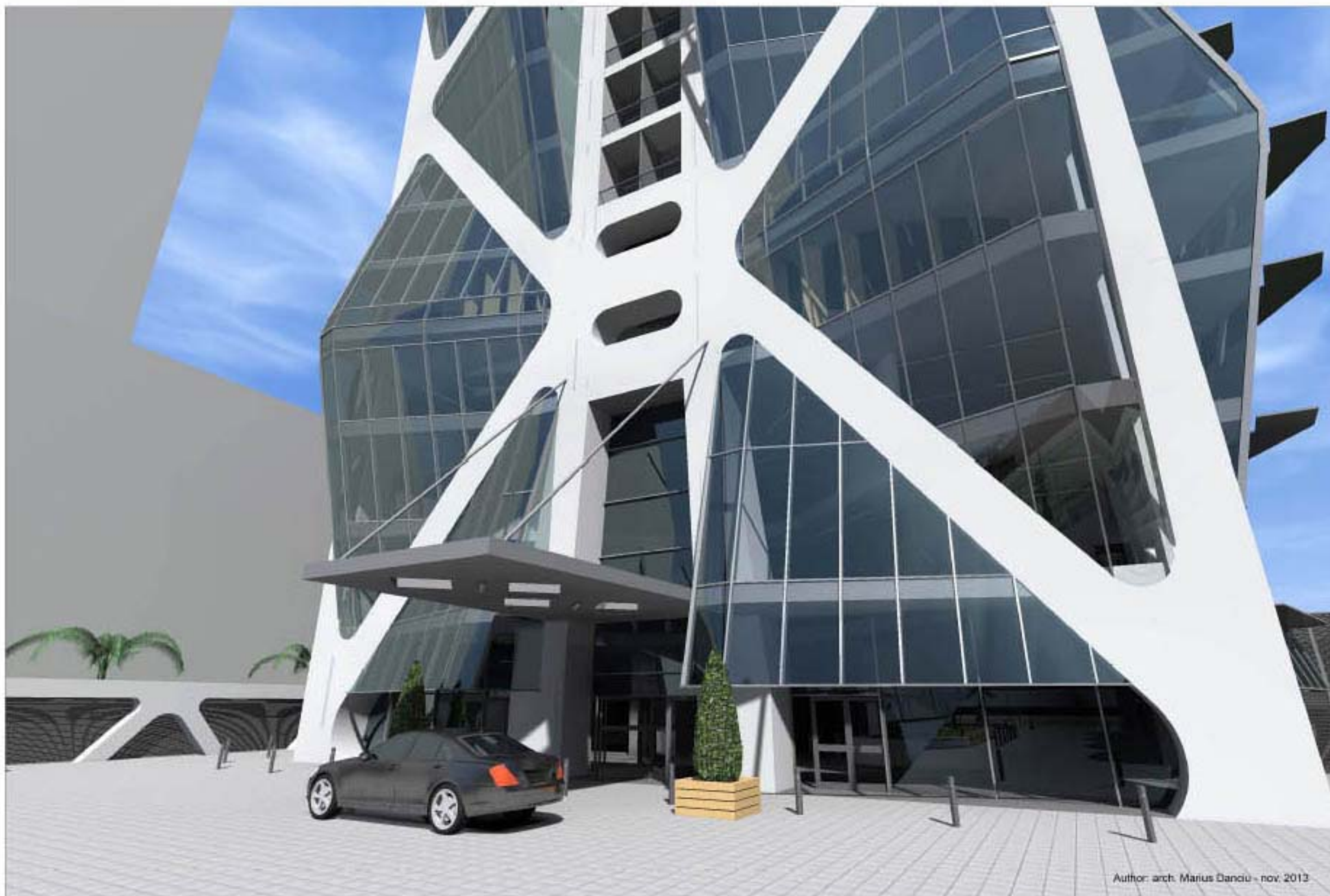

Author: arch. Marius Danciu - nov. 2013

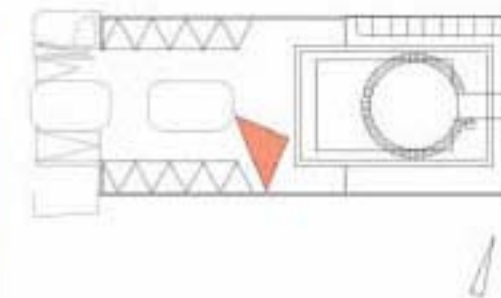

Exterior perspective 16

Marina Office Building

Office Building Concept Design
Location: Marina District, Doha, Qatar,
Plot: Marina Com 017
Date: Nov. 2013

Author:
Arch. Marius-Traian Danciu
Ecopolis Architecture Group-Bucharest

mariusdanciu.ecopolis@yahoo.com
marius.danciu@ecopolis.ro
tel: +40726 260424
www.ecopolis.ro
www.contactstudio.ro
www.proatrium.ro



Interior perspective 17
Reception Hall



Author: arch. Marius Danciu - nov. 2013

Marina Office Building

Office Building Concept Design
Location: Marina District, Doha, Qatar,
Plot: Marina Com 017
Date: Nov. 2013

Author:
Arch. Marius-Traian Danciu
Ecopolis Architecture Group-Bucharest

mariusdanciu.ecopolis@yahoo.com
marius.danciu@ecopolis.ro
tel: +40726 260424
www.ecopolis.ro
www.contactstudio.ro
www.proatrium.ro



Interior perspective 18
Commercial Area
Swimming Pool

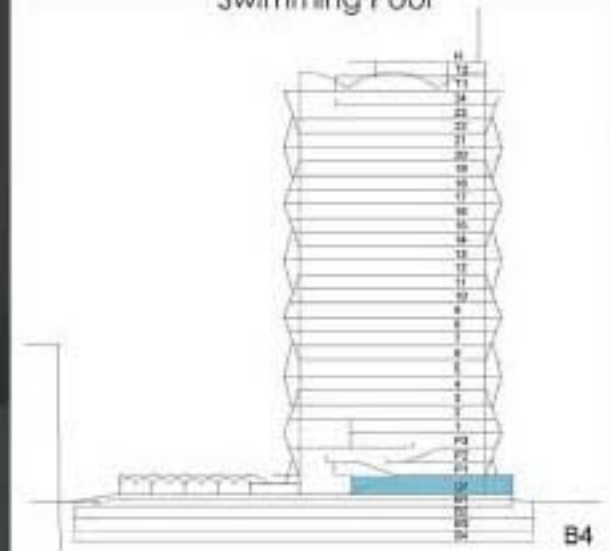

Marina Office Building

Office Building Concept Design
Location: Marina District, Doha, Qatar,
Plot: Marina Com 017
Date: Nov. 2013

Author:
Arch. Marius-Traian Danciu
Ecopolis Architecture Group-Bucharest

mariusdanciu.ecopolis@yahoo.com
marius.danciu@ecopolis.ro
tel: +40726 260424
www.ecopolis.ro
www.contactstudio.ro
www.proatrium.ro



Ecopolis
Architecture
Group

This project is the property of the Author and may not be used without his permission.

www.ecopolis.ro
www.contactstudio.ro



Interior perspective 19
Sky Restaurant



Author: arch. Maria Danciu - noi. 2013

Marina Office Building

Office Building Concept Design
Location: Marina District, Doha, Qatar,
Plot: Marina Com 017
Date: Nov. 2013

Author:
Arch. Marius-Traian Danciu
Ecopolis Architecture Group-Bucharest

mariusdanciu.ecopolis@yahoo.com
marius.danciu@ecopolis.ro
tel: +40726 260424
www.ecopolis.ro
www.contactstudio.ro
www.proatrium.ro



Interior perspective 20
Sky Restaurant



Author: arch. Marius Danou - nov. 2013

Marina Office Building

Office Building Concept Design
Location: Marina District, Doha, Qatar,
Plot: Marina Com 017
Date: Nov. 2013

Author:
Arch. Marius-Traian Danciu
Ecopolis Architecture Group-Bucharest

mariusdanciu.ecopolis@yahoo.com
marius.danciu@ecopolis.ro
tel: +40726 260424
www.ecopolis.ro
www.contactstudio.ro
www.proatrium.ro



Interior perspective 20
Sky Restaurant



Author: arch. Marius Traian Danciu - nov. 2013

Marina Office Building

Office Building Concept Design
Location: Marina District, Doha, Qatar,
Plot: Marina Com 017
Date: Nov. 2013

Author:
Arch. Marius-Traian Danciu
Ecopolis Architecture Group-Bucharest

mariusdanciu.ecopolis@yahoo.com
marius.danciu@ecopolis.ro
tel: +40726 260424
www.ecopolis.ro
www.contactstudio.ro
www.proatrium.ro



Ecopolis
Architecture
Group

This project is the property of the Author and may not be used without his permission.

www.ecopolis.ro
www.contactstudio.ro



Interior perspective 21
Auditorium



Author: arch. Marius Danciu - nov 2013

Marina Office Building

Office Building Concept Design
Location: Marina District, Doha, Qatar,
Plot: Marina Com 017
Date: Nov. 2013

Author:
Arch. Marius-Traian Danciu
Ecopolis Architecture Group-Bucharest

mariusdanciu.ecopolis@yahoo.com
marius.danciu@ecopolis.ro
tel: +40726 260424
www.ecopolis.ro
www.contactstudio.ro
www.proatrium.ro



Interior perspective 22
Auditorium



Author: arch. Marius Danciu / nov. 2013

Marina Office Building

Office Building Concept Design
Location: Marina District, Doha, Qatar,
Plot: Marina Com 017
Date: Nov. 2013

Author:
Arch. Marius-Traian Danciu
Ecopolis Architecture Group-Bucharest

mariusdanciu.ecopolis@yahoo.com
marius.danciu@ecopolis.ro
tel: +40726 260424
www.ecopolis.ro
www.contactstudio.ro
www.proatrium.ro

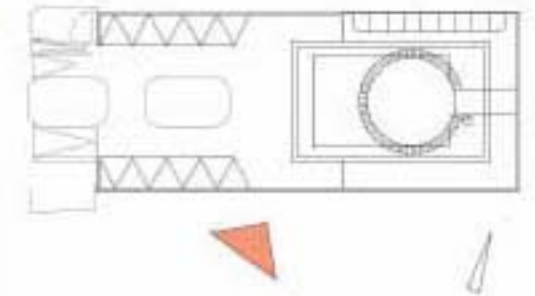
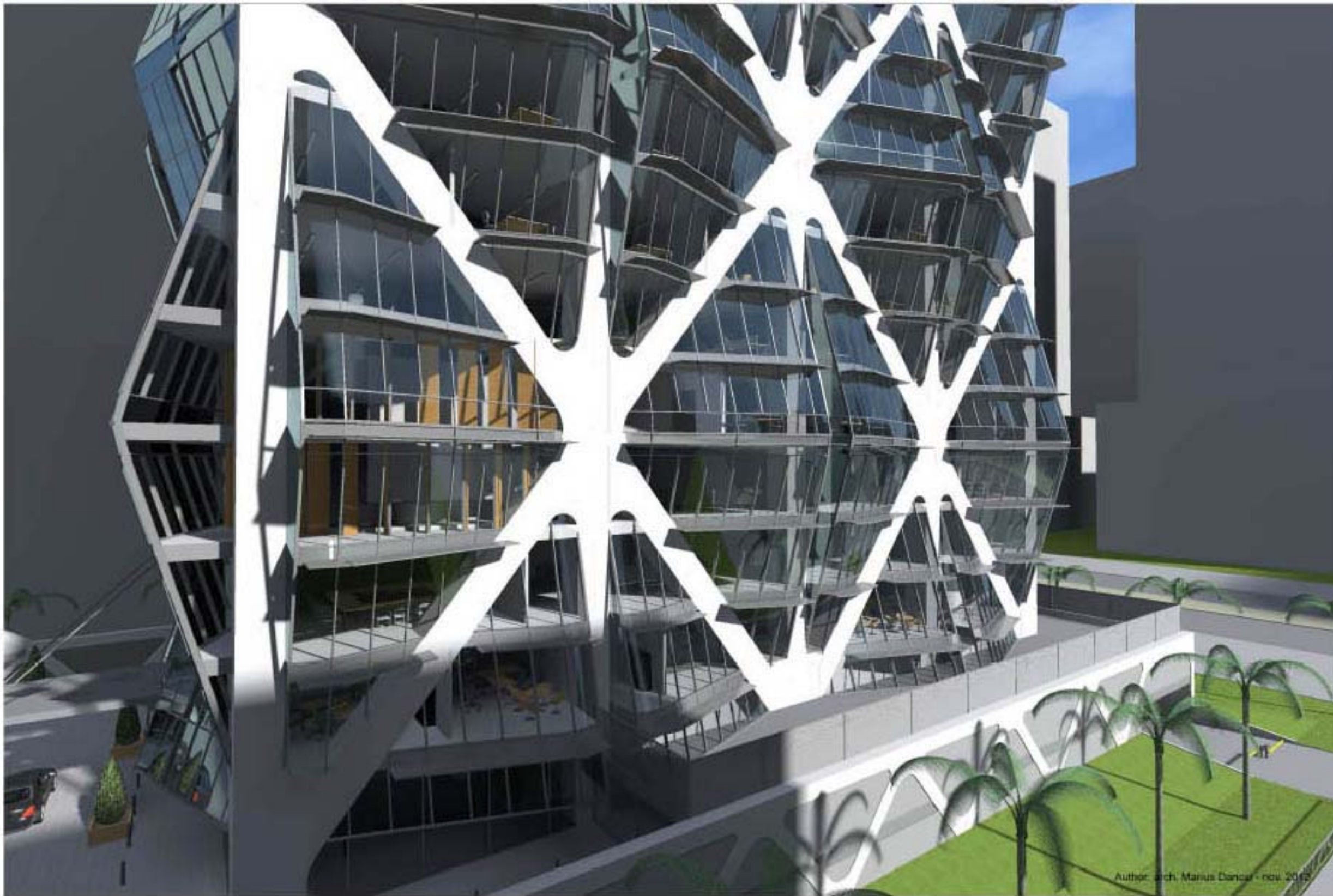

Exterior perspective 23

Marina Office Building

Office Building Concept Design
Location: Marina District, Doha, Qatar,
Plot: Marina Com 017
Date: Nov. 2013

Author:
Arch. Marius-Traian Danciu
Ecopolis Architecture Group-Bucharest

mariusdanciu.ecopolis@yahoo.com
marius.danciu@ecopolis.ro
tel: +40726 260424
www.ecopolis.ro
www.contactstudio.ro
www.proatrium.ro



Ecopolis
Architecture
Group

This project is the property of the Author and may not be used without his permission.

www.ecopolis.ro
www.contactstudio.ro

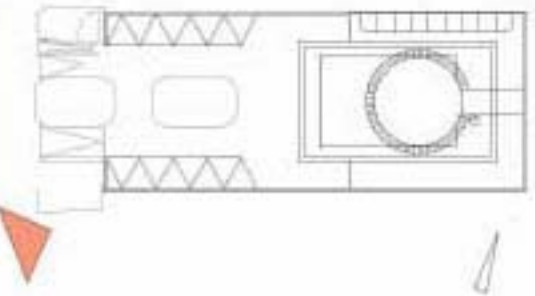
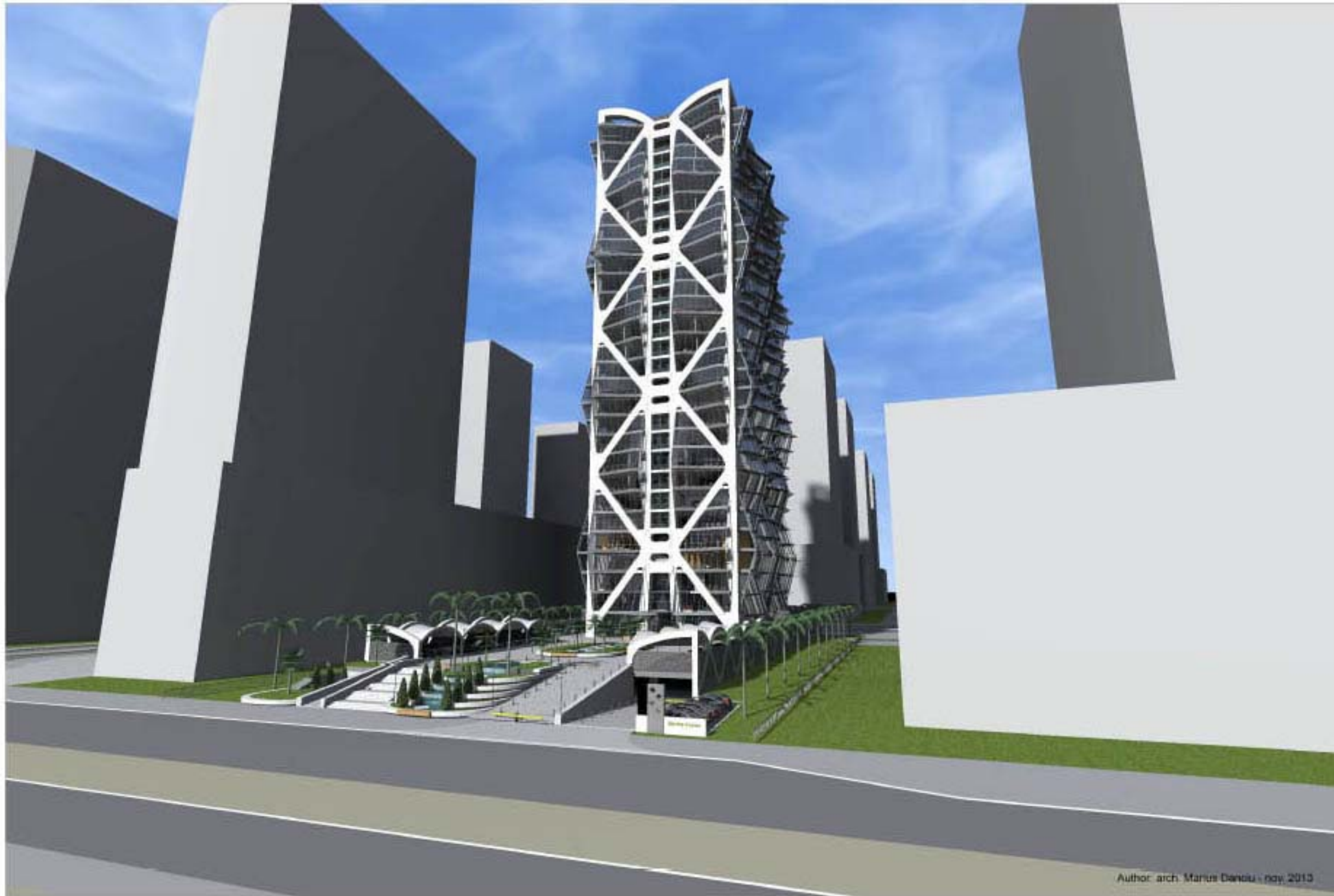

Exterior perspective 24

Author: arch. Marius Danciu - ngy, 2013

Marina Office Building

Office Building Concept Design
Location: Marina District, Doha, Qatar,
Plot: Marina Com 017
Date: Nov. 2013

Author:
Arch. Marius-Traian Danciu
Ecopolis Architecture Group-Bucharest

mariusdanciu.ecopolis@yahoo.com
marius.danciu@ecopolis.ro
tel: +40726 260424
www.ecopolis.ro
www.contactstudio.ro
www.proatrium.ro



Ecopolis
Architecture
Group

This project is the property of the Author and may not be used without his permission.

www.ecopolis.ro
www.contactstudio.ro

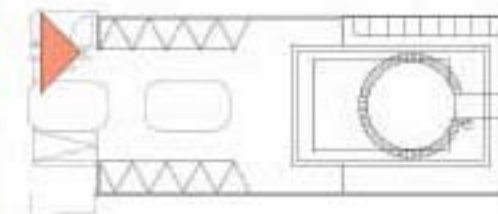

Exterior perspective 25
Canopy for car parking

Author: arch. Marius Danciu - odr 2013

Marina Office Building

Office Building Concept Design
Location: Marina District, Doha, Qatar,
Plot: Marina Com 017
Date: Nov. 2013

Author:
Arch. Marius-Traian Danciu
Ecopolis Architecture Group-Bucharest

mariusdanciu.ecopolis@yahoo.com
marius.danciu@ecopolis.ro
tel: +40726 260424
www.ecopolis.ro
www.contactstudio.ro
www.proatrium.ro

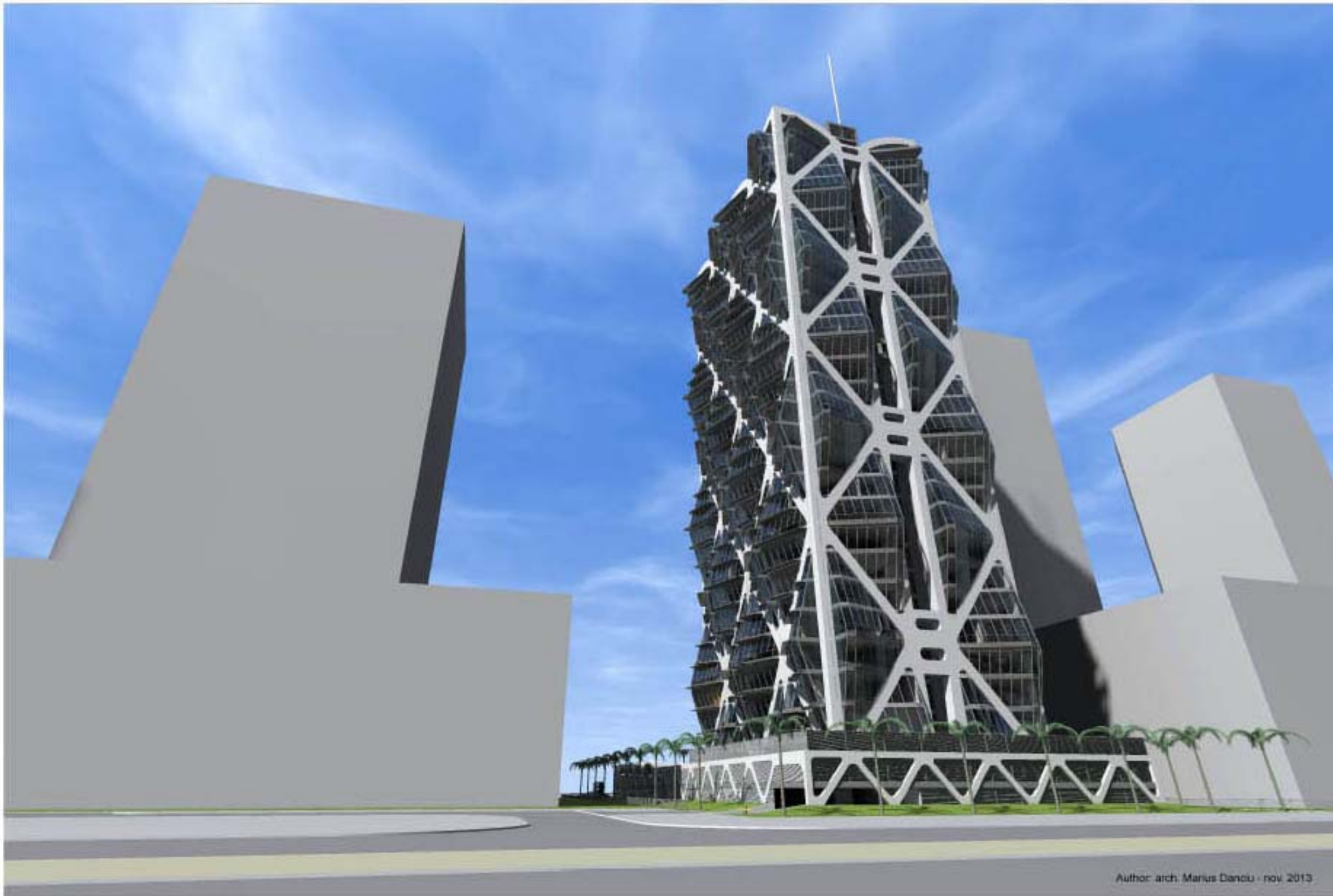

Author: arch. Marius Danciu - nov. 2013

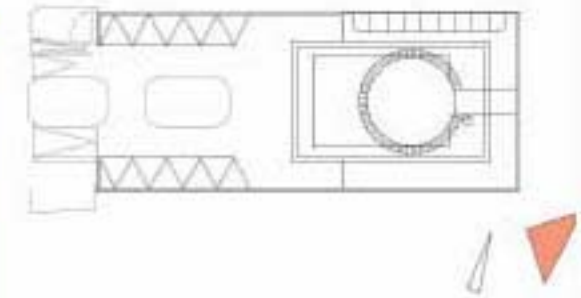

Exterior perspective 26

Marina Office Building

Office Building Concept Design
Location: Marina District, Doha, Qatar,
Plot: Marina Com 017
Date: Nov. 2013

Author:
Arch. Marius-Traian Danciu
Ecopolis Architecture Group-Bucharest

mariusdanciu.ecopolis@yahoo.com
marius.danciu@ecopolis.ro
tel: +40726 260424
www.ecopolis.ro
www.contactstudio.ro
www.proatrium.ro



Ecopolis
Architecture
Group

This project is the property of the Author and may not be used without his permission.

www.ecopolis.ro
www.contactstudio.ro

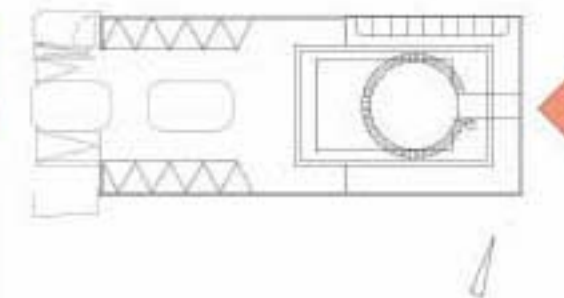
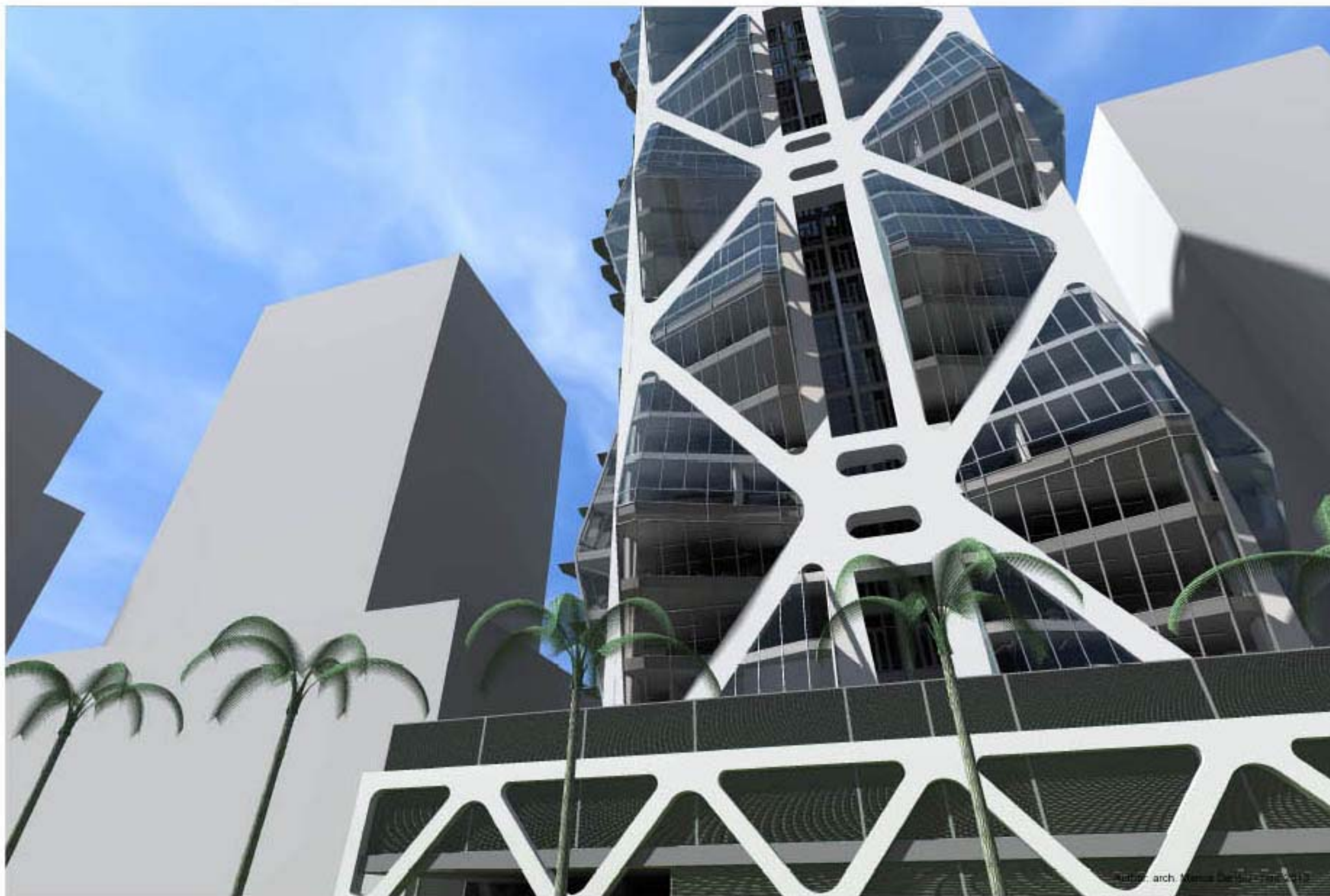

Exterior perspective 27

Marina Office Building

Office Building Concept Design
Location: Marina District, Doha, Qatar,
Plot: Marina Com 017
Date: Nov. 2013

Author:
Arch. Marius-Traian Danciu
Ecopolis Architecture Group-Bucharest

mariusdanciu.ecopolis@yahoo.com
marius.danciu@ecopolis.ro
tel: +40726 260424
www.ecopolis.ro
www.contactstudio.ro
www.proatrium.ro

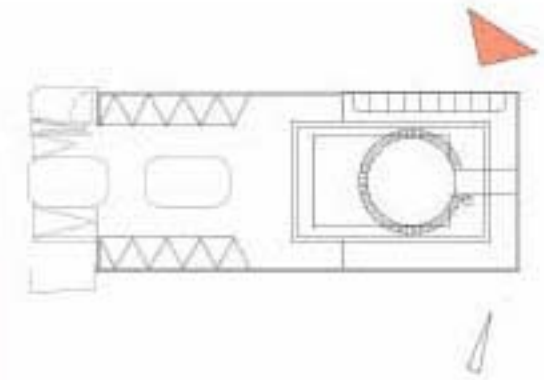
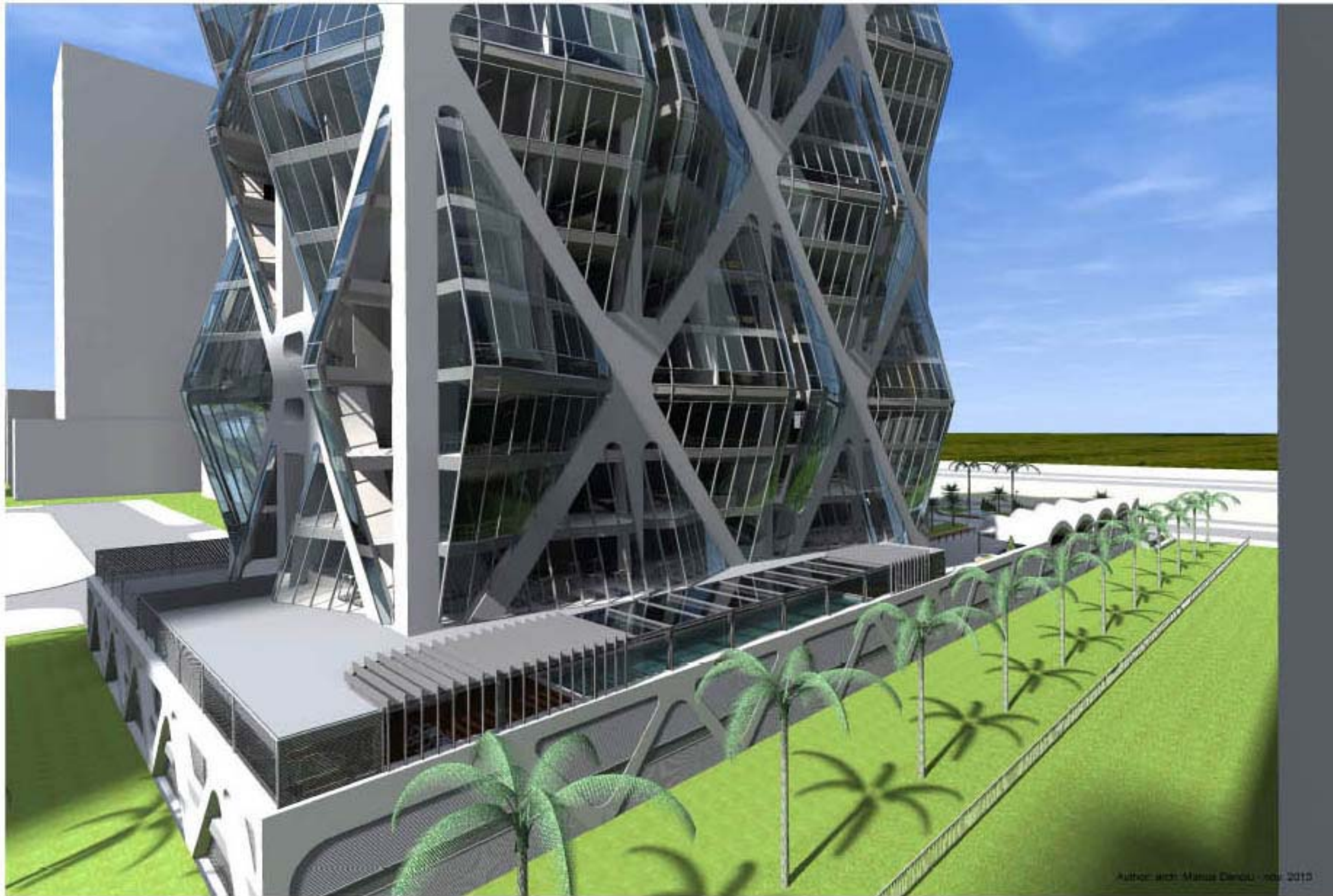

Exterior perspective 28

Author: arch. Marius Danciu - noi 2013

Marina Office Building
Office Building Concept Design
Location: Marina District, Doha, Qatar,
Plot: Marina Com 017
Date: Nov. 2013

Author:
Arch. Marius-Traian Danciu
Ecopolis Architecture Group-Bucharest

mariusdanciu.ecopolis@yahoo.com
marius.danciu@ecopolis.ro
tel: +40726 260424
www.ecopolis.ro
www.contactstudio.ro
www.proatrium.ro



This project is the property of the Author and may not be used without his permission.

www.ecopolis.ro
www.contactstudio.ro

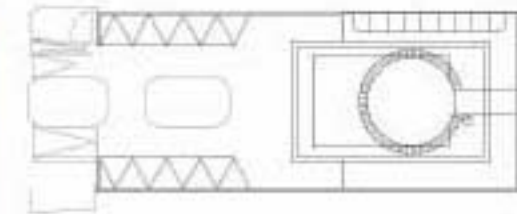

Exterior perspective 29

Author: arch. Marius Danciu - 2013

Marina Office Building

Office Building Concept Design
Location: Marina District, Doha, Qatar,
Plot: Marina Com 017
Date: Nov. 2013

Author:
Arch. Marius-Traian Danciu
Ecopolis Architecture Group-Bucharest

mariusdanciu.ecopolis@yahoo.com
marius.danciu@ecopolis.ro
tel: +40726 260424
www.ecopolis.ro
www.contactstudio.ro
www.proatrium.ro



Ecopolis
Architecture
Group

This project is the property of the Author and may not be used without his permission.

www.ecopolis.ro
www.contactstudio.ro

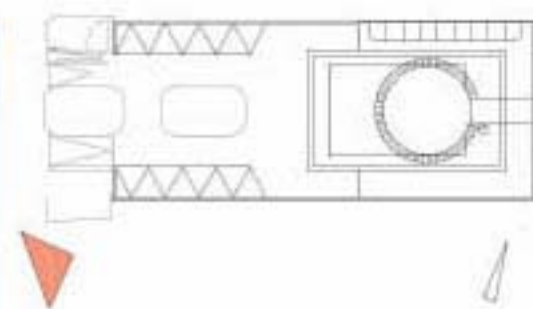

Exterior perspective 30

Author: arch. Marius Danciu - nov. 2013

Marina Office Building
Office Building Concept Design
Location: Marina District, Doha, Qatar,
Plot: Marina Com 017
Date: Nov. 2013

Author:
Arch. Marius-Traian Danciu
Ecopolis Architecture Group-Bucharest

mariusdanciu.ecopolis@yahoo.com
marius.danciu@ecopolis.ro
tel: +40726 260424
www.ecopolis.ro
www.contactstudio.ro
www.proatrium.ro



This project is the property of the Author and may not be used without his permission.

www.ecopolis.ro
www.contactstudio.ro

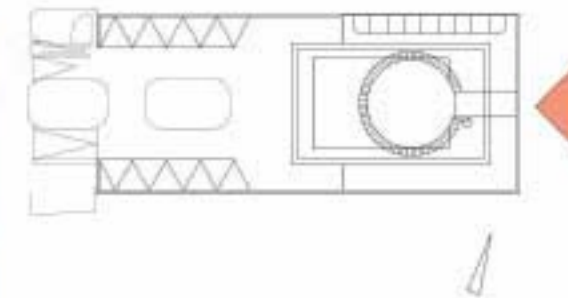
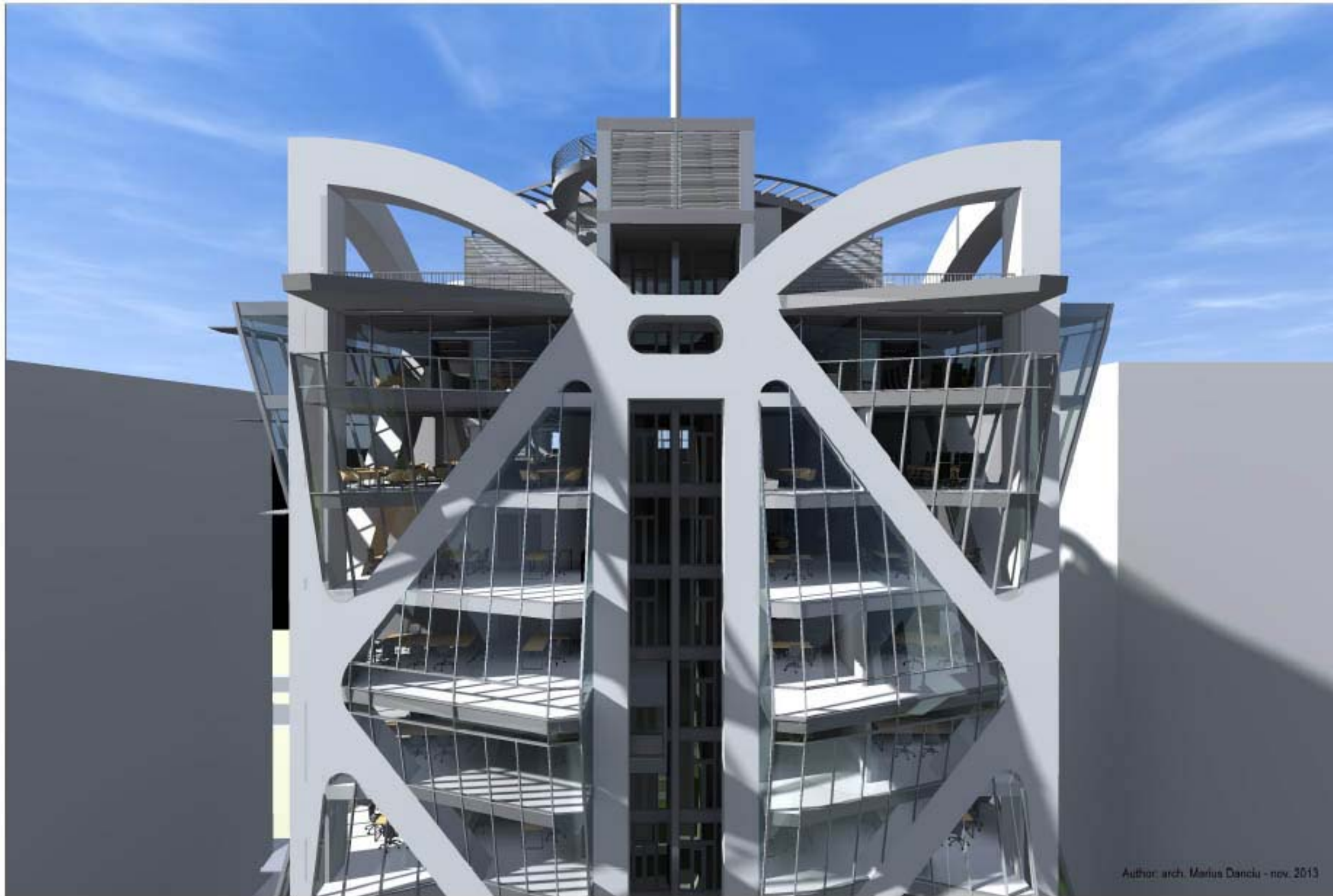

Exterior perspective 32

Author: arch. Marius Danciu - nov. 2013

Marina Office Building

Office Building Concept Design
Location: Marina District, Doha, Qatar,
Plot: Marina Com 017
Date: Nov. 2013

Author:
Arch. Marius-Traian Danciu
Ecopolis Architecture Group-Bucharest

mariusdanciu.ecopolis@yahoo.com
marius.danciu@ecopolis.ro
tel: +40726 260424
www.ecopolis.ro
www.contactstudio.ro
www.proatrium.ro



Ecopolis
Architecture
Group

This project is the property of the Author and may not be used without his permission.

www.ecopolis.ro
www.contactstudio.ro

Table of Areas

Story number	Area	Gross Area	Total Area	Direct Rentable Area Office + Commercial + Conference Rooms	Car Parking places
-4	Basement 4	-	5640	185	203
-3	Basement 3	-	5640	185	203
-2	Basement 2	-	5640	185	203
-1	Basement 1	-	4200	145	83
1	Ground Floor (incl. Parking)	2000	2500	685	24+6
2	1st Floor (Plinth)	1200	1200	630	
3	2nd Floor (Plinth)	1270	1270	630	
4	3rd Floor (Plinth)	1340	1340	640	
5	1st Floor (Office)	1090	1090	700	
6	2nd Floor (Office)	1340	1340	1040	
7	3rd Floor (Office)	1340	1340	1040	
8	4th Floor (Office)	1340	1340	1040	
9	5th Floor (Office)	1340	1340	1040	
10	6th Floor (Office)	1340	1340	1040	
11	7th Floor (Office)	1340	1340	1040	
12	8th Floor (Office)	1340	1340	1040	
13	9th Floor (Office)	1340	1340	1040	
14	10th Floor (Office)	1340	1340	1040	
15	11th Floor (Office)	1340	1340	1040	
16	12th Floor (Office)	1340	1340	1040	
17	13th Floor (Office)	1340	1340	1040	
18	14th Floor (Office)	1340	1340	1040	
19	15th Floor (Office)	1340	1340	1040	
20	16th Floor (Office)	1340	1340	1040	
21	17th Floor (Office)	1340	1340	1040	
22	18th Floor (Office)	1340	1340	1040	
23	19th Floor (Office)	1340	1340	1040	
24	20th Floor (Office)	1340	1340	1040	
25	21st Floor (Office)	1340	1340	1040	
26	22nd Floor (Office)	1340	1340	1040	
27	23rd Floor (Sky Restaurant)	1340	1340	1065	
28	24th Floor (Sky Bar)	1160	1160	745	
29	Technical Floor 1	685	685	-	
30	Technical Floor 2	230	230	-	
Total: 34					
	Total Gross Area	38.455			
	Total Area		60.075		
	Total Rentable Area			27.635	
	Total Car Park Number				722

*This is a preliminary table of areas. Legal / technical requirements or modification in the technical project (that could not be analyzed at this preliminary phase) can change this values.

Marina Office Building

Office Building Concept Design
Location: Marina District, Doha, Qatar,
Plot: Marina Com 017
Date: Nov. 2013

Author:
Arch. Marius-Traian Danciu
Ecopolis Architecture Group-Bucharest

mariusdanciu.ecopolis@yahoo.com
marius.danciu@ecopolis.ro
tel: +40726 260424
www.ecopolis.ro
www.contactstudio.ro
www.proatrium.ro

